

User Manual

MKA 500 / MKA 800

Programmable Controller for Cooking, Universal, Baking and Boiler System as well as Autoclaves

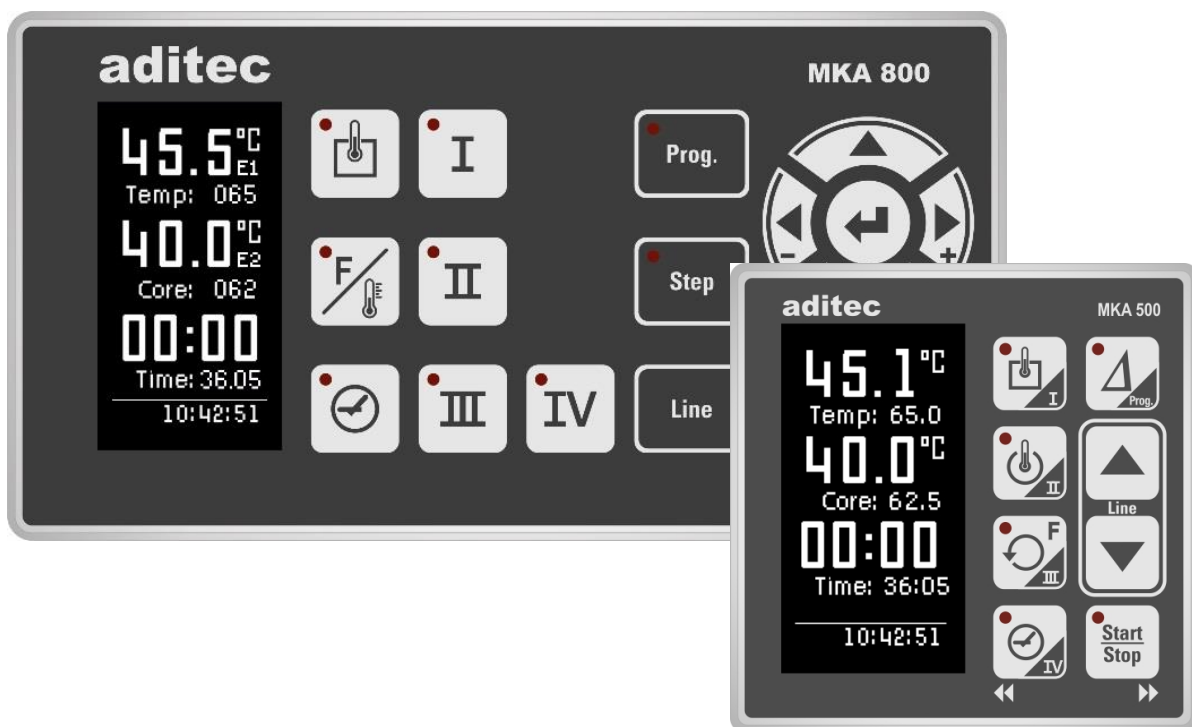

Version V00.13

Issue 21.02.2023_01

Measurement and
Control technology
Hardware development
Software development
Specialised electronics
Food technology
Process visualisation

aditec
CONTROLS for
FOODTECHNOLOGY

aditec gmbh
Talweg 17
D-74254 Offenau
Tel.:+49(0)7136 96122-0
Fax:+49(0)7136 96122-20
www.aditec.net
eMail: info@aditec.net









Contents

1 Introduction	5
1.1 Overview	5
2 Operating controls	6
2.1 Operating controls MKA 500.....	6
2.2 Operating controls MKA 800.....	7
2.3 Button functions	8
2.3.1 MKA 500.....	8
2.3.2 MKA 800.....	9
2.3.3 Skipping between nominal values.....	9
2.4 LED Display	10
2.4.1 LED Display MKA 500.....	10
2.4.1 LED Display MKA 800.....	10
2.5 Status and use of button relays and aggregate relays (if enabled)	11
2.6 Interval times.....	11
3 Control elements	12
3.1 Entering values (Edit box).....	12
3.2 General text entry (Edit box)	12
3.2.1 Sequence of the characters:	13
3.2.2 Deleting a character:	13
3.3 Buttons	13
3.4 Check boxes	13
3.5 List boxes	14
3.6 Drop boxes.....	14
4 Relevance of the nominal values	14
4.1 Entering nominal values.....	14
4.2 Switching off nominal values.....	14
4.3 Nominal temperature	15
4.4 Nominal core temperature	15
4.5 Step time	15
4.6 Optional nominal values.....	15
4.6.1 Delta temperature (Delta-T process)	16
4.6.2 FC value	16
4.6.3 Aggregate modules (<i>direct relay actuation</i>)	17
4.6.4 Optional control loops	17
4.6.5 Step-by-step control	18
4.7 Shut-down condition	18
4.8 Negative core shut-down (<i>Shower/Cooling</i>).....	18
4.9 Pre-heating function.....	19
5 Standby	19
6 Program set-up	20
6.1 Program set-up (Standby) MKA 500.....	20
6.1.1 Entering a temperature	20
6.1.2 Entering a core temperature	20
6.1.3 Entering an operating time	21
6.1.4 Optional nominal values.....	21
6.2 Program set-up (Standby) MKA 800.....	21
6.2.1 Entering a temperature	21
6.2.2 Entering a core temperature	21
6.2.3 Entering an operating time	22
6.2.4 Optional nominal values.....	22
6.3 Program start	22
6.3.1 Start from standby MKA 500	22
6.3.2 Start from standby MKA 800	22
6.3.3 Starting a program with a batch number MKA 500	23
6.3.4 Starting a program with a batch number MKA 800.....	23

6.3.5 Starting a program with starting time MKA 500	23
6.3.6 Starting a programs with starting time MKA 800.....	24
6.4 Programming mode	24
6.4.1 Programming mode MKA 500.....	24
6.4.2 Programming mode MKA 800.....	26
6.4.2.1 Program – Step selection.....	26
6.4.2.2 Program entry.....	27
6.4.2.3 Changing nominal values within a step.....	27
6.4.2.4 Terminating programming mode	27
6.5 Linking programs	28
6.6 Copying, deleting and inserting programs/steps	28
7 Operating mode - displays and settings	30
7.1 Nominal values	30
7.1.1 Aggregate/relais and digital inputs display.....	31
7.1.2 Aggregate modules	31
7.1.3 Optional control loops	32
7.2 Status bar.....	32
7.2.1 Program progression (from version V00.06 onwards)	32
7.2.2 Remaining program runtime.....	32
7.2.3 Messages (<i>system status messages</i>).....	32
7.2.4 Alarms	33
7.3 Alarm signal	33
7.4 Program runtime, operating time display in operating mode	33
8 Profile settings.....	34
8.1 Setting date and time of day	34
8.1.1 Automatic change-over between summer and normal time	35
8.2 Display settings	35
8.3 Status bar display	36
8.4 Enabling signal relay.....	37
8.5 Enabling a batch number	38
8.6 Data logger	39
8.6.1 Copying data onto a USB stick	40
8.7 Enabling VisuNet program	41
8.8 Version number display	41
8.9 Sensor information.....	42
8.10 Screen saver	43
9 Power failure	43
10 List of errors (possible problems)	44
11 Connecting the controller to a PC	45
11.1 Connection cables, different types of connection	45
11.1.1 Connection via an Ethernet interface:	45
11.1.2 Connection via a RS485 interface:	45
11.2 Enable VisuNet	46
12 Technical data.....	46
12.1 MKA 500	46
12.2 MKA 800	46
13 Dimensions / connection diagrams.....	46
13.1 Dimensions / connection diagrams MKA 500.....	46
13.2 Dimensions / connection diagrams MKA 800.....	47
14 Additional boards / Interface options.....	48
15 Index	49
16 Safety instructions	50

Symbols used in this user manual

The following symbols are used in this user manual to highlight important information:

Symbol	Description
	See page / press button
	Press several buttons simultaneously
	This symbol indicates a useful hint or gives a tip.
	Factory setting
	Display is flashing
	Be aware! This symbol points out measures you should take in order to avoid potential problems.
	Code is supported by the service program
	Press a button for 3 seconds or wait 3 seconds.
	Indicates a sequence of actions that should be executed one after the other.

1 Introduction

1.1 Overview

Process controllers **MKA 500** and **MKA 800** with 2,7" LED display (128 x 64 Pixel and 16 grey scales) various interfaces and industry-standard housing are designed for use in cooking, universal, baking and boiler systems as well as autoclaves and can be adapted to many other applications.

In their standard version, the controllers are equipped with **4 Pt100 temperature inputs and 2 convertable inputs** for either Pt100 and current 4-20mA / voltage 0-10V or thermo- elements (conforming to DIN EN 60584).

For communication the following interface is available: Mini USB interface

To facilitate adaptation for different applications, each control loop can be used as 2 point controller, XP controller or with PID behaviour.

MKA 500:

The standard version has 5 relay outputs (1 normally open contacts and 4 change-over contacts) as well as 5 virtual relays.

MKA 800:

The standard version has 10 relay outputs (6 normally open contacts and 4 change-over contacts) as well as 5 virtual relays.

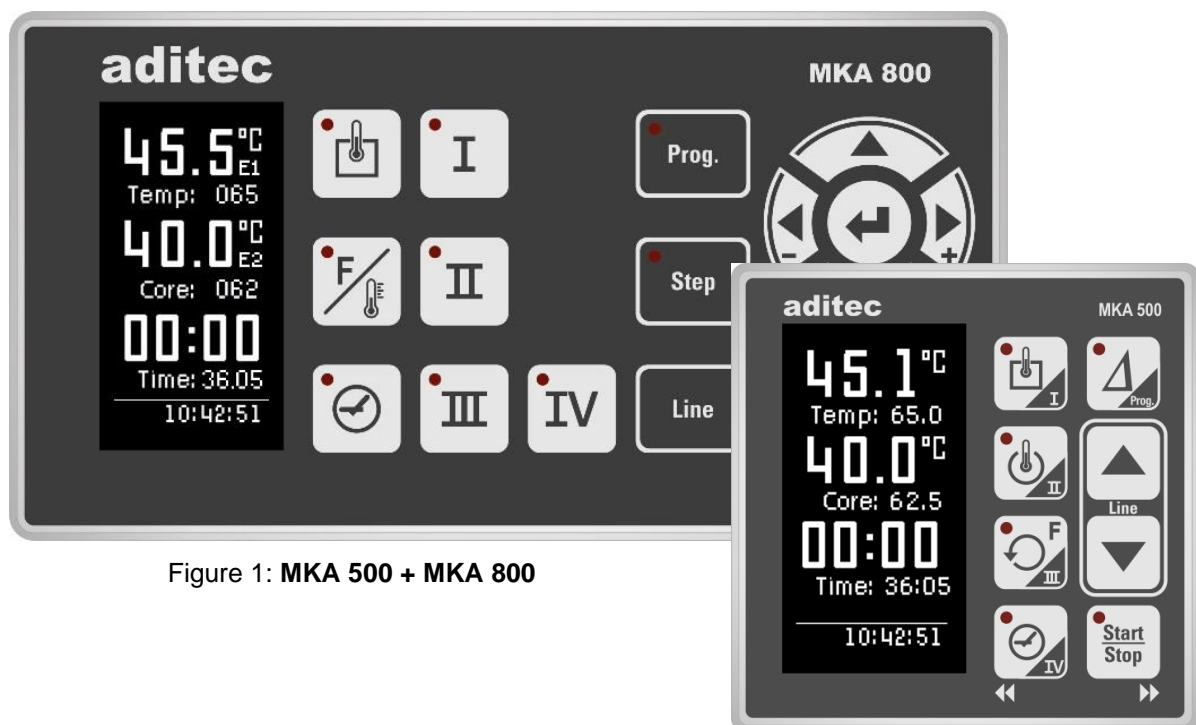

Figure 1: MKA 500 + MKA 800

2 Operating controls

2.1 Operating controls MKA 500

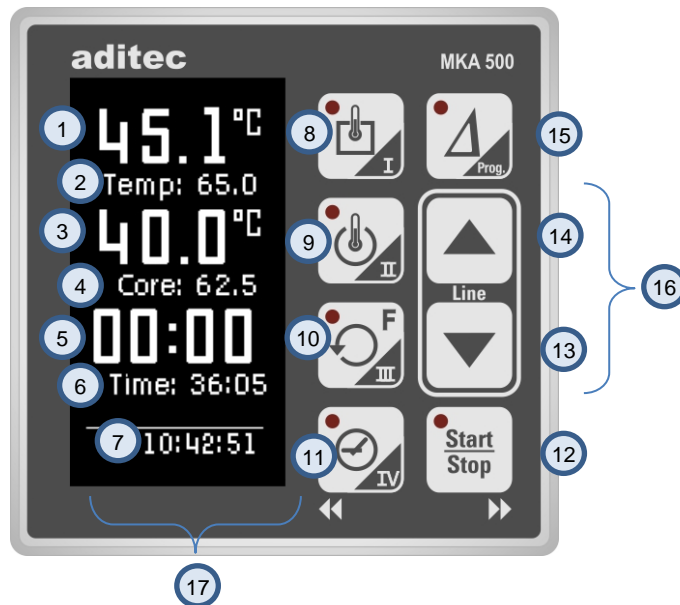

Figure 2: Operating controls MKA 500

- ① Actual value temperature (*Temp*) / short cut button I
- ② Nominal values / short cut button I/ Nominal Delta value
- ③ Actual value core temperature / short cut buttons II and III
- ④ Nominal values short cut buttons II and III
- ⑤ Actual value step time/program runtime/remaining program time/ cut button IV
- ⑥ Nominal step time/ cut button IV
- ⑦ Current time of day
- ⑧ Temp. button / short cut button I
- ⑨ Core button / short cut button II
- ⑩ Humidity button cut button III
- ⑪ Time button /left/ cut button IV
- ⑫ Start/Stop button /right
- ⑬ Cursor button down
- ⑭ Cursor button up
- ⑮ Delta button
- ⑯ Line button (press up and down button simultaneously)
- ⑰ Display

2.2 Operating controls MKA 800

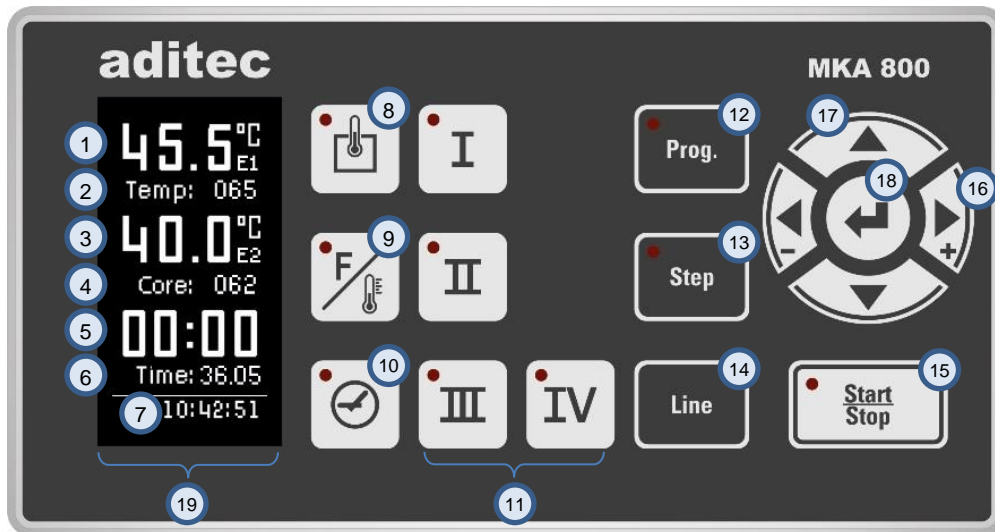

Figure 3: Operating controls MKA 800

- 1 Actual value temperature
- 2 Nominal value temperature
- 3 Actual value core temperature
- 4 Nominal value core temperature
- 5 Actual value step time/program runtime/remaining program time
- 6 Nominal step time
- 7 Current time of day
- 8 Temperature button
- 9 Core temperature button
- 10 Time button
- 11 Button for free configuration (e.g. Delta temperature)
- 12 "Prog" button
- 13 "Step" button
- 14 "Line" button
- 15 "Start/Stop" button
- 16 Button controlling the cursor position on the display
- 17 Button for changing nominal values /selecting settings
- 18 "Enter" button / Confirming settings

2.3 Button functions

2.3.1 MKA 500









Button	Description	Function
	Temperature „Temp“	Short cut button for entering the following nominal values: temperature (<i>min, max</i>)
	Core temperature „Core“	Short cut button for entering the following nominal values: core temperature
	„Humidity“	Short cut button for entering the following nominal values: humidity (<i>min, max</i>)
	„Time“	Short cut button for entering the following nominal value: step time
	Delta	Short cut button for entering the following nominal value: Delta
	Start/Stop	Starting and stopping programs
	Cursor buttons	Moving the cursor within the display, selecting specific settings
	Line	Confirming an entry and focussing the next item by briefly pressing both cursor buttons simultaneously. Leaving the screen (<i>code</i>) by pressing  and holding both cursor buttons simultaneously. 3 Sec.

Table 1: Button functions MKA 500

2.3.2 MKA 800













Button	Description	Function
	Temperature „Temp“	Shortcut button for entering: Nominal temperature (<i>min, max</i>)
	Core temperature „Core“	Shortcut button for entering: Nominal core temperature
	„Time“	Short cut button for entering: Nominal step time
	Start/Stop	Starting and stopping programs
	Cursor	Moving the cursor within the display, Selecting certain settings
	Settings	Changing nominal values, Selecting settings
	Enter	Confirming settings
	Prog.	Selecting a program
	Step	Selecting a program step
	Line	Confirming an entry and focussing the next item by clicking once. Leaving the screen (<i>code</i>), by pressing for at least 3 sec. 
	Shortcut buttons I II III IV	Shortcut buttons: Shortcut buttons I-IV (e.g. Delta temperature, humidity, single step control, aggregate modules)

Table 2: Button functions MKA 800

2.3.3 Skipping between nominal values

If several nominal values have been allocated to one button and you press it, e.g.  , **the nominal value that was selected last will be focussed**. Further nominal values can be displayed by pressing the button again.

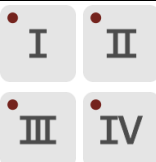
2.4 LED Display

2.4.1 LED Display MKA 500

Button	LED off	LED on	Relevance
Temperature „Temp“			LED „is flashing“ when a nominal value is changed.
Core temperature „Core“			LED „is flashing“ when a nominal value is changed
„Humidity“			LED „is flashing“ when a nominal value is changed.
Delta			LED „is flashing“ when a nominal value is changed.
„Time“			LED „is flashing“ when a nominal value is changed.
Start / Stop			LED „is flashing“ when the controller is in waiting mode or pause mode, if there has been an alarm or the end of a program has been reached. LED is lit when the controller is in operation.

Table 3: LED Display MKA 500

2.4.1 LED Display MKA 800

Button	LED off	LED on	Relevance
Temperature „Temp“			LED „is flashing“ when a nominal value is changed.
Core temperature „Core“			LED „is flashing“ when a nominal value is changed
„Time“			LED „is flashing“ when a nominal value is changed
Start / Stop			LED „is flashing“ when the controller is in waiting mode or pause mode, if there has been an alarm or the end of a program has been reached. LED is lit, when the controller is in operation
Prog.			LED „is lit“ when a program is selected
Step			LED „is lit“ when a step is selected
Shortcut buttons I II III IV			LED „is flashing“ when a nominal value is changed.

Table 4: LED display MKA 800

2.5 Status and use of button relays and aggregate relays (if enabled)

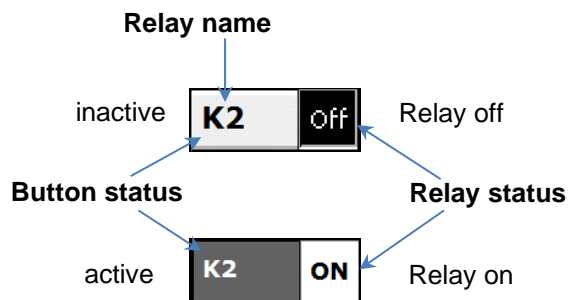
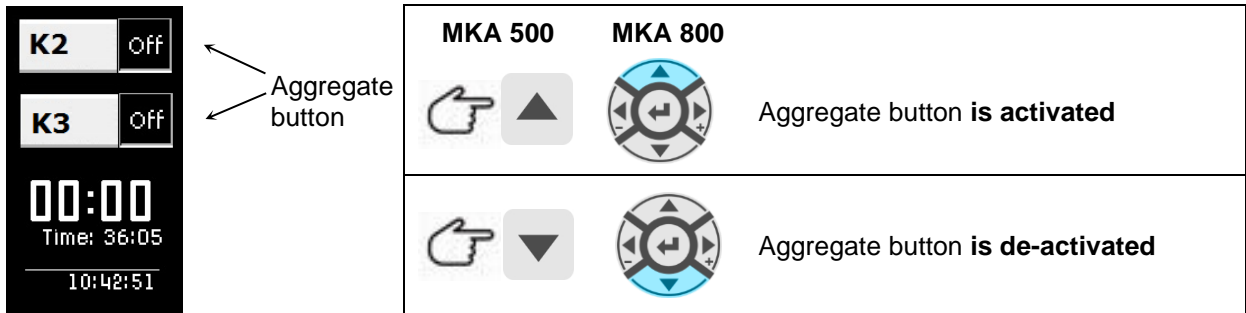

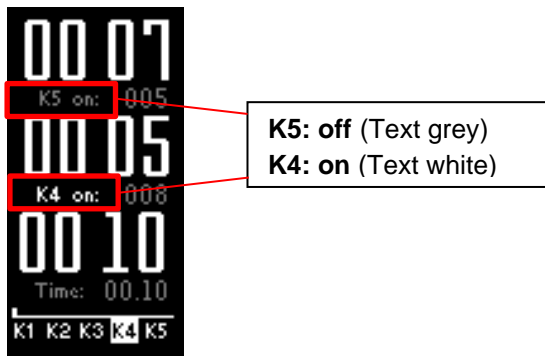

2.6 Interval times

When the relay is active, the text of the nominal value is highlighted in white.





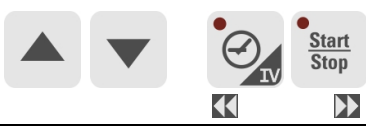



3 Control elements



3.1 Entering values (Edit box)



	<p>MKA 500:</p>  <p>Values/numbers are entered by using the arrow buttons.</p>
<p>Figure 4: Value entry</p>	<p>MKA 800:</p>  <p>Enter numbers via the navigation pad</p>

How to enter values:

- Cursor is flashing in the position ‚far right‘: „00“.
- When you are making an entry, the cursor is at first in the position ‚far right‘: „00“. Use the  button (MKA500) /  (MKA800) to increase the value and  button (MKA500) /  (MKA800) to reduce the value. The numbers will automatically shift to the left „10“. The number value you enter is limited by the limit value range.
- When you press the arrow button ‚left‘, you can change the individual digits.





<p>Entering negative values</p>		<p>Certain nominal values can be negative numbers (e.g. <i>temperature values</i>). In order to enter a negative value you have to press the arrow button „down“ until you go past value 0, when a minus („ - „) sign will appear in front of the numbers</p>
<p>MKA 500</p> 	<p>MKA 800</p> 	

<p>Entering positive values:</p>		<p>When you want to change a negative number into a positive one, you can position the cursor on the „-“ sign and overwrite it with a „+“ via the arrow button „up“ or you can enter a value higher than „0</p>
<p>MKA 500</p> 	<p>MKA 800</p> 	

<p>Hint</p>		
	<p>Scrolling characters:</p> <p>MKA 500 MKA 800</p>   <p>Use the arrow buttons „up“ / „down“ (keep pressed) to scroll a character.</p>	

3.2 General text entry (Edit box)

How to enter text:

- Cursor is flashing in the first position: „_“.
- When you are making an entry the cursor is at first in the position „_“. Use the  button (MKA500) /  (MKA800) to scroll up the characters (number/letter/ special character), or the  (MKA500) /  (MKA800) button to scroll them down. Use the arrow buttons ‚left‘ or ‚right‘ to change the individual digits. In this way you can take the cursor to any position in the entry box.

Characters can only be entered in the position that is flashing. Press the relevant button „up“ or „down“ until the required character appears. The first character is a blank.

3.2.1 Sequence of the characters:

Numbers:												
' '	'0'	'1'	'2'	'3'	'4'	'5'	'6'	'7'	'8'	'9'		
Letters:												
'A'	'B'	'C'	'D'	'E'	'F'	'G'	'H'	'I'	'J'	'K'	'L'	'M'
'N'	'O'	'P'	'Q'	'R'	'S'	'T'	'U'	'V'	'W'	'X'	'Y'	'Z'
'a'	'b'	'c'	'd'	'e'	'f'	'g'	'h'	'i'	'j'	'k'	'l'	'm'
'n'	'o'	'p'	'q'	'r'	's'	't'	'u'	'v'	'w'	'x'	'y'	'z'
Special characters:												
'.'	','	':'	';'	'!'	'"'	'\$'	'%'	'&'	'/'	'(')'	'{'
'}'	'['	']'	'='	'?'	'+'	'-'	'*'	'_'	'#'	'@'	'~'	

Table 5: Table of characters

3.2.2 Deleting a character:

If you want to **overwrite a character** use the arrow buttons ,left' and ,right' to take the cursor to the required position and enter the new character in this position.

If you want to **delete a character**, take the cursor to the right of the position you want to delete. Press the „Temp“ button to backspace and the character is deleted

Hint



Scrolling through the characters:

MKA 500



MKA 800



Use the arrow buttons „up“ / „down“ (keep pressed) to scroll a character.

3.3 Buttons



Figure 5:
 Button

The button allows the user to trigger an assigned function. When the button is focussed (*frame around the info text*), it can be activated by using the ,Line' button. If several buttons exist, you can use the arrow buttons “up” or “down”, respectively, to focus the subsequent or previous button.

3.4 Check boxes



Figure 6:
 Check box

Check boxes allow you to set e.g. a status. When a check box is focussed (*frame around the info text*) you can change its status from **selected** (*Relay 1*) to **not selected** (*Relay 2,3*) by using the ,Line' button. If several check boxes exist you can use the arrow buttons “up” or “down” respectively to focus the subsequent or previous check box

3.5 List boxes

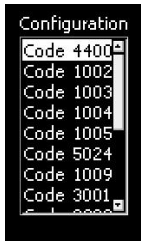

List boxes allow you to clearly display items, e.g. codes, in a list. Use the arrow buttons “up” and “down” to focus an entry (*background = white, writing = black*) and the ‚Line‘ button to select it. The scroll bar gives you only an overview. The scroll bar is automatically moved when the last item of the visible segment is focussed with the arrow buttons.

Figure 7:
List box

3.6 Drop boxes

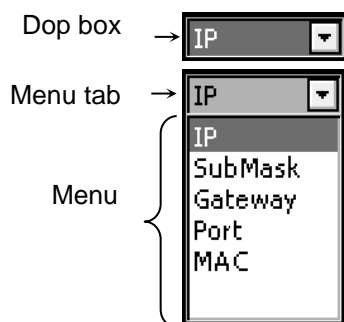

A drop box is used to select one item from a shown list of items. Initially, the previously selected item is shown. Use the arrow buttons “up” or “down” respectively to focus the subsequent or previous item. When you press the ‚Start‘ button, a menu of all available items on the list will flick open and you can use the arrow buttons “up” or “down” respectively to focus the subsequent or previous item. (*background = grey, writing = white*). The currently selected item is shown on the menu tab. Use the ‚Time‘ button to shut the drop box and the newly chosen item is automatically selected.

Figure 8:
Drop box

4 Relevance of the nominal values

The controller allows you to pre-program different nominal values within a program step. In the following chapter, the relevance of the individual nominal values is explained.

Be aware
Depending on the system and the application, nominal values can be configured in different ways for individual processes. This means that you may find that not all the nominal values described here are available in your controller (<i>it depends on your specific configuration</i>). This manual describes all the available values

4.1 Entering nominal values

Nominal value entry will be automatically cancelled after 10 seconds, if none of the buttons have been pressed.
 The nominal value that is shown at that time is saved.

4.2 Switching off nominal values

Be aware
Switching off nominal values: Nominal values in the controller can also be negative. Therefore value „0“ is also a valid nominal value. If you want to switch off a nominal value in a program step, e.g. the core temperature, the ▼ button (MKA500) / ⚙️ (MKA800) has to be pressed repeatedly until the value „OFF“ appears.

4.3 Nominal temperature

Nominal value for chamber temperature control. The chamber temperature is regulated via the heating relay (*when the actual value is smaller than the nominal value*) and/or cooling relay (*when the actual value is higher than the nominal value*). If two nominal values, „Chamber min“ and „Chamber max“, have been enabled for temperature control, the heating process will use nominal value „**Chamber min**“ and the cooling process will use „**Chamber max**“.

	Be aware
	Temperature control with low pressure steam via humidifying:
	The temperature is controlled with low pressure steam and not through heating. Low pressure steam is blown into the chamber via the humidifying valve with 2 Point behaviour.
	Activation of temperature control with low pressure steam via humidifying: Enter value 100 as the min. value for humidity (transiently or in programming mode). <u>This function is only available, if it has been enabled by the service technician!</u>

4.4 Nominal core temperature

	Be aware
	Shut-down condition: If you have enabled the nominal core temperature value in a step and the core sensor reaches this nominal value, the step will be terminated.

The controller works with two types of core shut-down:

Positive core shut-down (heating operation)

If the pre-programmed nominal temperature value is higher than the nominal core temperature value, the controller will switch to the next step as soon as the actual core temperature is higher or equal to the nominal core temperature.

Negative core shut-down (cooling operation)

If the pre-programmed nominal temperature value is lower than the nominal core temperature value, the controller will switch into the next step. When the actual core temperature is lower or equal to the nominal core temperature, the controller will also switch into the next step.

4.5 Step time

The step time is the duration of a step.

Entering a step time

While a step is running, the step time is counted backwards. When the pre-programmed step time has elapsed, the controller will switch into the next step.

	Be aware
	No pre-set step time: If you have not entered a step time, the time will be counted forward while the step is running. (<i>in this way you always know how long the step has been in operation</i>).

4.6 Optional nominal values

A service technician can make further nominal values available by changing the configuration of the controller. The relevance of these nominal values can vary, this is why your service technician should explain them to you. The following description is just a list of possible applications.

4.6.1 Delta temperature (Delta-T process)

Cooking with the Delta-T process (Delta temperature control) allows you to heat the product gently and evenly. When using this process the chamber temperature is always kept higher, by the nominal Delta value, than the actual core temperature of the product. This means the temperature difference between the surface and the core of the product always remains constant. The pre-set nominal temperature value is used as an upper limit value for temperature control. A lower nominal Delta value will prolong the duration of the cooking process and the heating process is gentler, a higher nominal Delta value will speed up the cooking process.

	Hint
Apart from a nominal temperature value and a nominal Delta value, you can also enter a nominal core value, which will be used as core shut-down condition for the step.	

4.6.2 FC value

	Hint
Bacteria have to be killed through pasteurisation (FC70) / sterilisation (FC121). How thoroughly the bacteria are killed depends on the temperature and the length of time this temperature is maintained. A mathematical formula can be applied to this process. The degree to which the bacteria are killed is called FC value.	

The process:

It is the aim of **sterilisation** to kill all the bacteria and their spores. How thoroughly the bacteria are killed depends on the temperature and the length of time this temperature is maintained. A mathematical formula can be applied to this process.

$$F = \sum \left(\frac{10^{\left(\frac{(core\ temperature) - T_{ref}(reference\ temperature)}{z\text{-Value}} \right)}}{\left(\frac{60}{Sampling\ rate} \right)} \right)$$

The degree to which the bacteria are killed is called F-value.

For meat cans F-value 1 means the bacteria extermination which is achieved at a core temperature of 121,1°C, when maintained for one minute. How thoroughly the bacteria are killed also depends on the acidity of the conserved product. Acidic preserves, fruit juices, pickled gherkins etc have a higher killing rate and therefore a different FC value table than normal meat preserves with a PH value between 5 and 7.

In order to avoid confusion, two further indicators can be added to the F-value, e.g. FC 121-10 (z-value), this means that at a core temperature of 121,1°C and a time of one minute, the F-value = 1. If the temperature is increased by 10°C, the F-value increases 10-fold.

Example of FC-value 121:

$$FC121 = 10^{\left(\frac{T(core\ temperature) - 121.1^{\circ}C}{10} \right)}$$

Example FC-value 70:

$$FC70 = 10^{\left(\frac{T(core\ temperature) - 70^{\circ}C}{10} \right)}$$

	Hint
Depending on the setting, the nominal FC value is shown as displayed below.	
<ul style="list-style-type: none"> ▪ FC70 (pasteurisation), see example FC value 70 ▪ FC121 (sterilisation), see example FC value 121. ▪ FC-UD, user defined settings 	

	Be aware
Shut-down condition:	
When the pre-programmed FC-value has been reached, the controller will automatically switch into the next step or terminate the program, respectively.	

4.6.3 Aggregate modules (*direct relay actuation*)

Up to 5 aggregate modules can be pre-programmed, thereby influencing the switching behaviour of specific relays and the connected hardware (*aggregates*). The configuration determines which nominal values may be entered and they can vary depending on the system. For example an aggregate can be simply switched on or off, or the interval times of a clocking relay can be changed

 Item 6.1.4, Optional nominal values MKA 500, p. 21

 Item 6.2.4, Optional nominal values MKA 800, p. 22

The names for the aggregate modules shown in standby, operating and programming mode are generated from the relay names.

Current interval times for the aggregate modules are shown during operation:

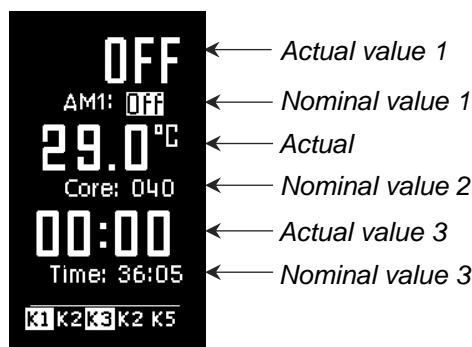

Depending on which switching behaviour has been configured by the service technician, different nominal value will be available to the end user in standby, operating and programming mode. During operation the current actual value and the current nominal value is shown. If you have set a switch-on interval and a switch-off interval for an aggregate module, the interval times will be shown alternately in the actual value display.

The status of the aggregate module button (*without delay*) is shown on the button.



Be aware

If a nominal value is changed during operation via VisuNet, the display will be updated (*reset*).

4.6.4 Optional control loops

Up to 6 optional regulators can be programmed. The configuration determines which nominal values may be entered and they can vary depending on the system. In this way the end user has the option of programming the nominal values of these regulators for the different program steps.



Be aware

The configuration determines the significance of the nominal values of the individual regulators.

If additional control loops or additional sensors have been configured for the process that is currently in operation, their current temperature values (*actual values*) will be displayed.

 Item 6.1.4, Optional nominal values MKA 500, p. 21

 Item 6.2.4, Optional nominal values MKA 800, p. 22

4.6.5 Step-by-step control

- The controller can be configured to pause at the end of every step. The message „Stop: one step control active“ will be shown and the signal relay will be energised for a time interval that can be pre-programmed.

The following message will appear on the display:



- Press "Yes" to switch into the next step
- Press "No" to close the message and return to the operating page.

There are 4 ways of how to proceed::

1. The operator can manually enter a step number and the program will continue with the selected step.
2. The nominal value that caused the program to pause, e.g. step time, can be changed. Then press the „Start/Stop“ button and the controller will repeat the step which was paused
3. The nominal value for step-by step control can be changed to „OFF“ , Then press the „Start/Stop“ button and the controller will continue the program with the next step (if programmed).
4. Keep the „Start/Stop“ button pressed, which will lead to the immediate termination of the program.

4.7 Shut-down condition

As soon as at least one of the shut-down conditions has been fulfilled, the program step will be terminated. If a nominal value has not been pre-programmed (*OFF*), the related switch-off condition is disabled.

Shut-down conditions are:

- Nominal step time has elapsed and has reached 00.00
- Nominal core value has been reached
- Negative core shut-down (*cooling, e.g. shower*)
- Nominal FC-value has been reached
- Nominal humidity value has been reached

Unplanned shut-down if:

- „Stop“ button is pressed which leads to a program termination
- There is a temperature sensor fault which always leads to a program termination
- There is a core sensor fault, program termination only when a nominal value has been pre-programmed
- There is a humidity sensor fault, program termination only when a nominal value has been pre-programmed

	Be aware
	An empty (<i>not valid</i>) program step will immediately be terminated or not even started. A program step is considered valid when one process has been pre-programmed.

4.8 Negative core shut-down (*Shower/Cooling*)

In order to pre-program a **negative core shut-down**, the nominal temperature value you enter has to be lower than the nominal core temperature value.

The program step will end when the actual core temperature falls below the nominal core temperature. If an operating time has also been entered, the program step will end when the operating time has run out **or** when the actual core temperature falls below the nominal core temperature. This means the program step will end when at least one of the shut-down conditions has been fulfilled.

4.9 Pre-heating function

The pre-heating function has an influence on how the step time is counted while a program is running. When this feature is activated, the controller only starts counting the step time when the nominal chamber temperature is reached **for the first time**. („Act. temp“ is higher than nominal value „Temp min“).

There are two possible settings:

- 1) The program that is running is not interrupted and the step time counter starts automatically.
- 2) The program is paused and the display will show the message „Temperature reached!“, the „Start/Stop“ button will be flashing. The program will only be resumed when the „Start/Stop“ button is pressed , at which point the step time counter will start.

	Be aware
	As soon as the nominal temperature has been reached, the message "Temperature reached! Continue?" will be shown, even if the rest time interval is still running.

	Hint
	This function is pre-configured by your service technician!

5 Standby

As soon as the controller is connected to a power source it will automatically boot up. This can take up to 1 minute.

	Be aware
	Please do not use pointy objects to operate the controller (e.g. pointed fingernails, biros, sharpened pencils or screw drivers). Only use blunt, soft objects, as e.g. your finger tips, a rubber or similar objects.

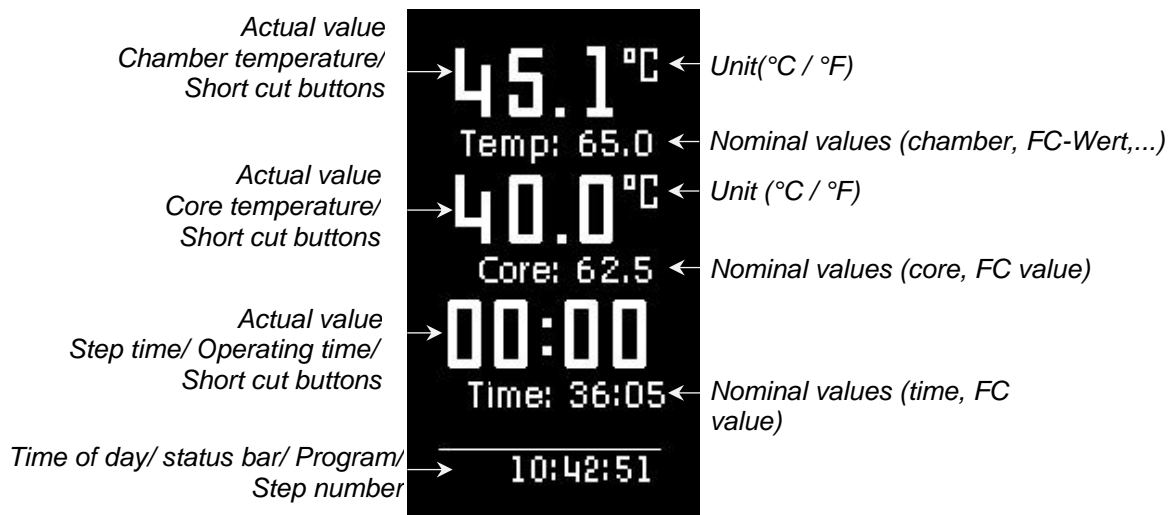



Figure 9: Standby

On the standby mask the current values and nominal values are shown as well as the current program and step numbers.

	Hint
	During a data transfer between the PC and the controller the standby mask is hidden and an status page is shown.

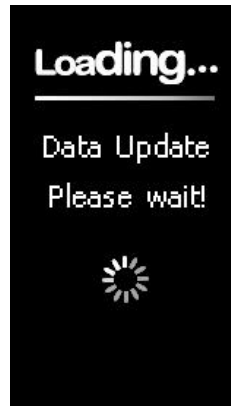



Figure 10: Data update

Hint
 Press any button, to leave standby. By pressing and holding the „Start“ button you can always return to standby. <i>(When the system is not in operation).</i>

6 Program set-up

Be aware
 The number of programs available may vary depending on the type of system you have and the application. You can only access programming mode when the pre-set number of programs is greater than 0 <i>(please ask your service technician)</i> . If the number of programs is set to 0, only one program (manual program) is available, you can set up this program from standby.

6.1 Program set-up (Standby) MKA 500

6.1.1 Entering a temperature

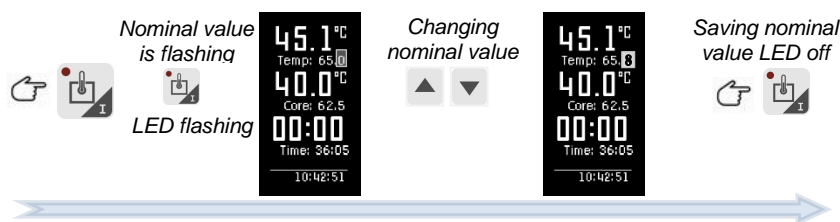

6.1.2 Entering a core temperature

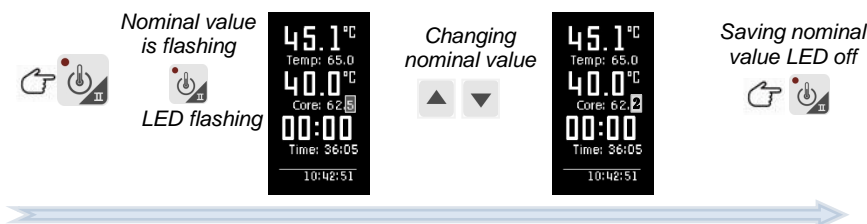

6.1.3 Entering an operating time

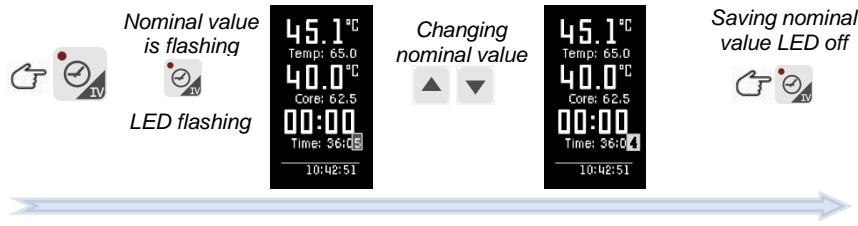

6.1.4 Optional nominal values

Be aware

 Depending on the system and the application, nominal values can be configured in different ways for individual processes. This means that you may find that not all the nominal values described here are available in your controller (*it depends on your specific configuration*).

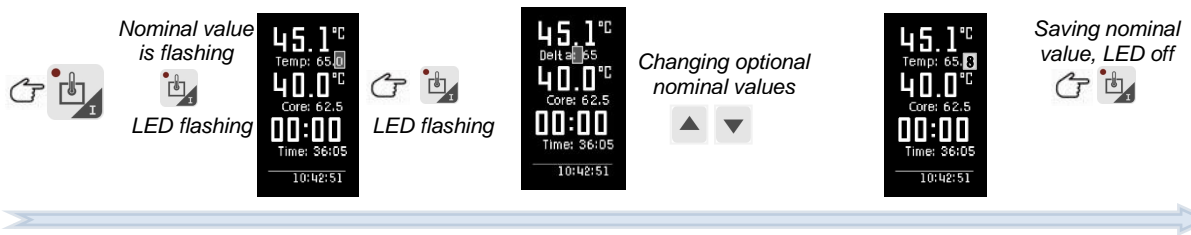

6.2 Program set-up (Standby) MKA 800

6.2.1 Entering a temperature

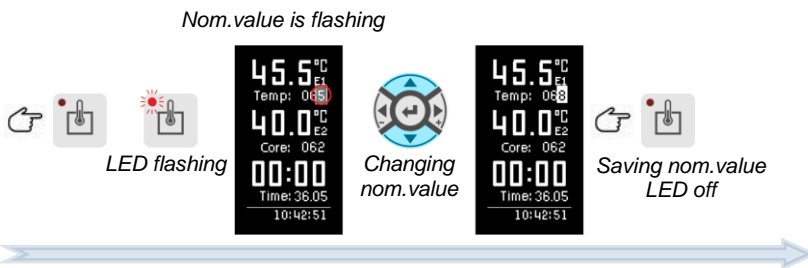

6.2.2 Entering a core temperature

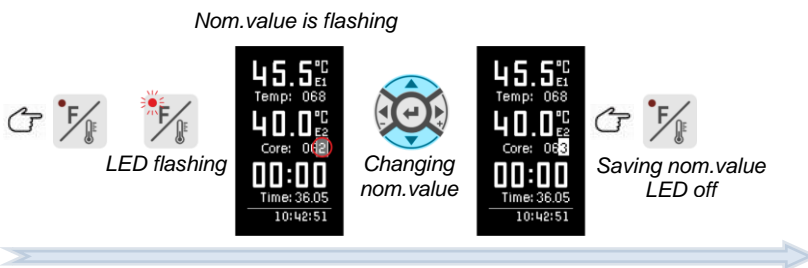

6.2.3 Entering an operating time

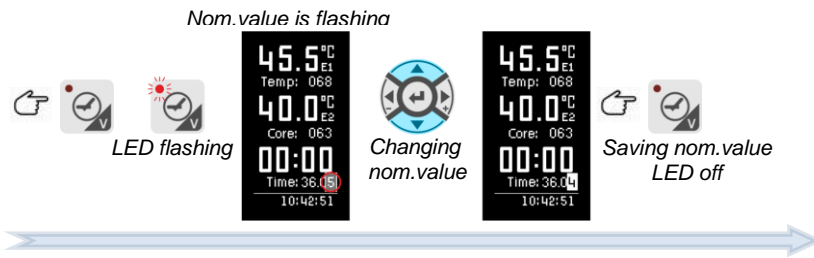

6.2.4 Optional nominal values

Achtung

Depending on the system and the application, nominal values can be configured in different ways for individual processes. This means that you may find that not all the nominal values described here are available in your controller (*it depends on your specific configuration*).

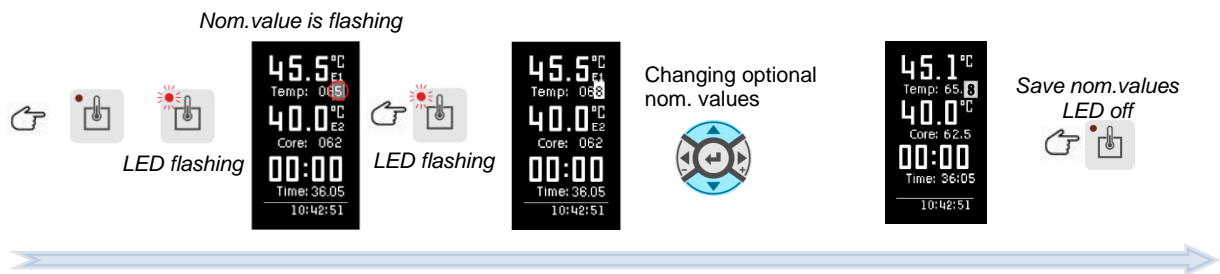

6.3 Program start

6.3.1 Start from standby MKA 500

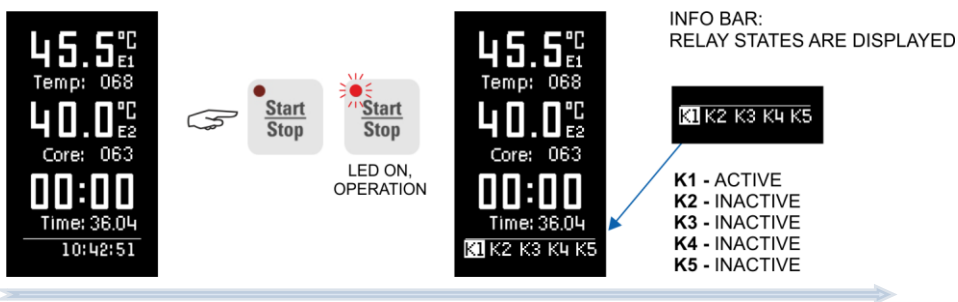

6.3.2 Start from standby MKA 800

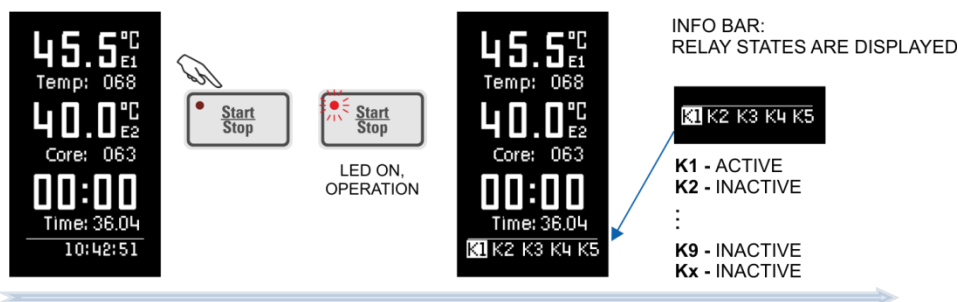

6.3.3 Starting a program with a batch number MKA 500

Once you have selected a program and have entered the relevant nominal values, the program can be started with the „Start/Stop“ button.

If the „Batch no“ function is enabled, the controller is now going to ask for a batch name.

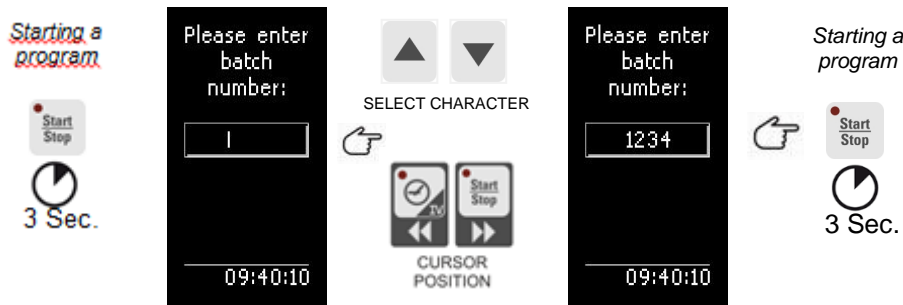

6.3.4 Starting a program with a batch number MKA 800

Once you have selected a program and have entered the relevant nominal values, the program can be started with the „Start/Stop“ button.

If the „Batch no“ function is enabled, the controller is now going to ask for a batch name.

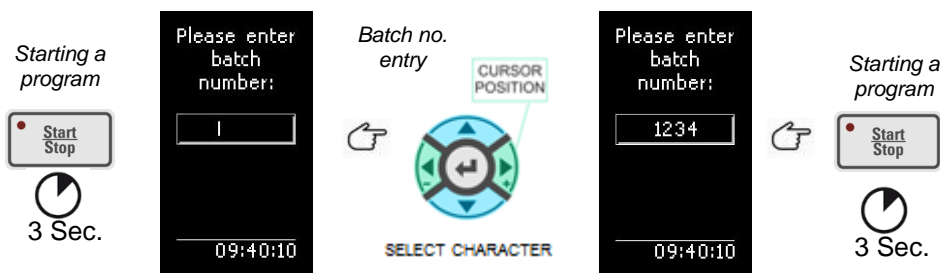

Hint
A batch number has to be entered when this feature has been enabled or the program cannot be started. The batch description can consist of up to 10 characters. By pressing the „Line“ button for about 3 seconds you can terminate the starting process.

6.3.5 Starting a program with starting time MKA 500

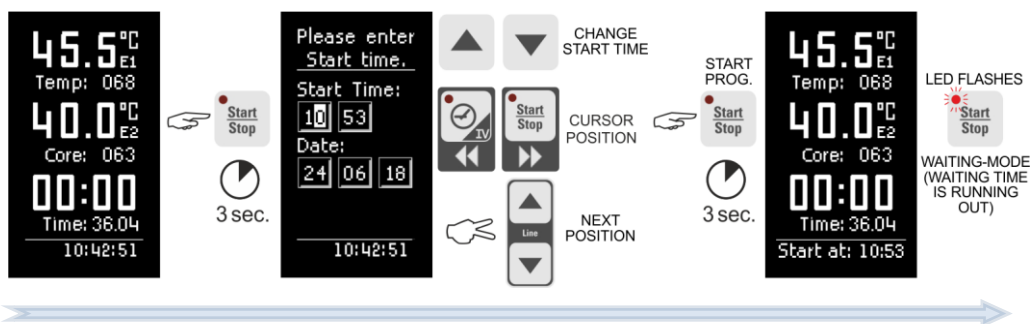

Hint
While the waiting time interval is running, the LED in the „Start/Stop“ button will be flashing. If you press this button, waiting mode will be terminated and the controller will return to standby mode.
By pressing the „Line“ button for about 3 seconds, the start process can be terminated.

6.3.6 Starting a programs with starting time MKA 800

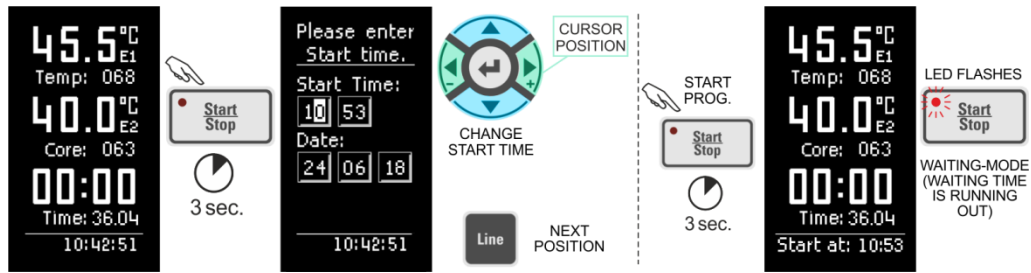

Hint

While the waiting time interval is running, the LED in the „Start/Stop“ button will be flashing. If you press this button, waiting mode will be terminated and the controller will return to standby mode.

By pressing the „Line“ button for about 3 seconds, the start process can be terminated.

6.4 Programming mode

Be aware

Access to programming mode is only possible when the pre-set number of programs is higher than 0 (please ask your service technician).

6.4.1 Programming mode MKA 500

6.4.1.1 Program – Step selection

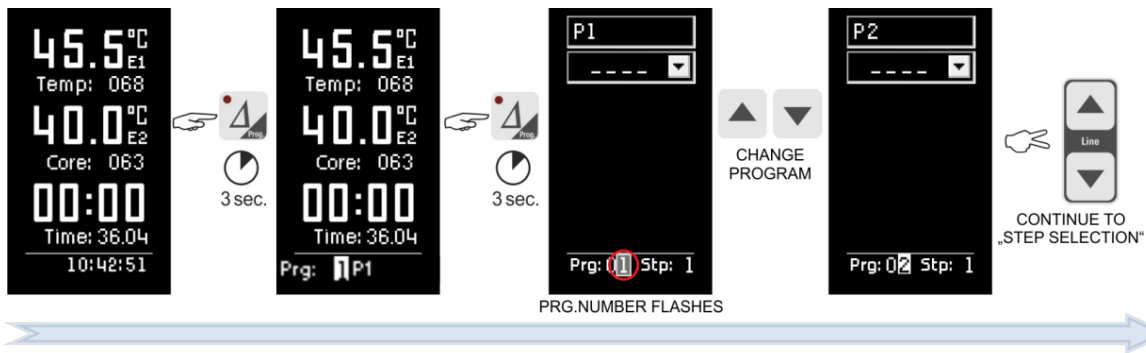

When you press function button Delta  and keep it pressed, the program selection function on the status bar will be activated. Now you can change the program.

If you are in program selection mode and you press the Delta button  again, programming mode will be started.

Be aware

"Prg.no." has to be selected under "Profiles → Status bar" (see item 8.3 "Status bar display", page 36)

If this is not the case, the controller will go straight into programming mode the first time you press the  button longer.

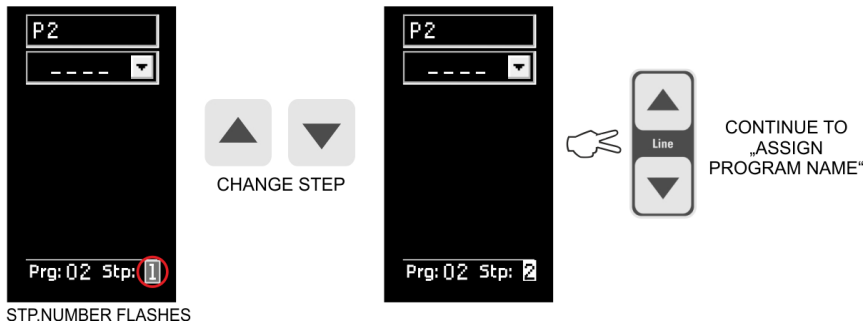

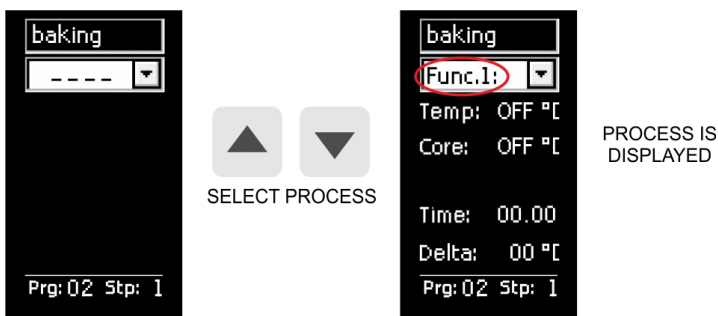
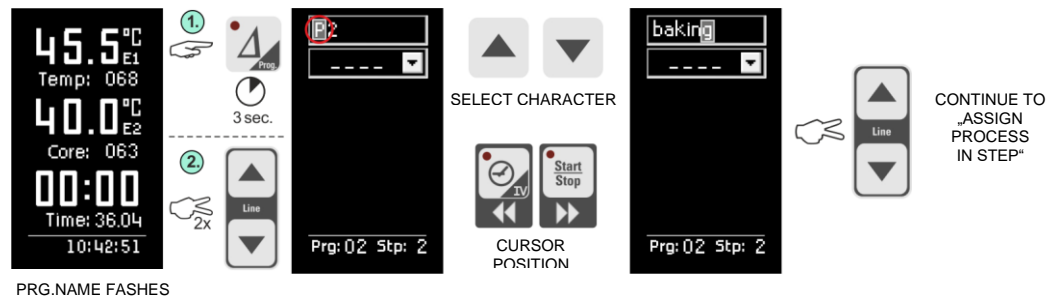

6.4.1.2 Program entry

Hint
 The program name can consist of max. 8 characters.

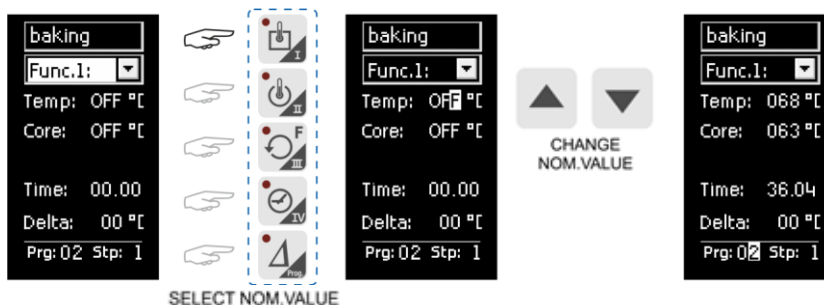

6.4.1.3 Changing nominal values within a step



	Hint
Only nominal values that have been enabled in the configuration can be entered/ changed here.	

6.4.1.4 Terminating programming mode

Press the  button for about 3 seconds and programming mode will be terminated.



6.4.2 Programming mode MKA 800

6.4.2.1 Program – Step selection

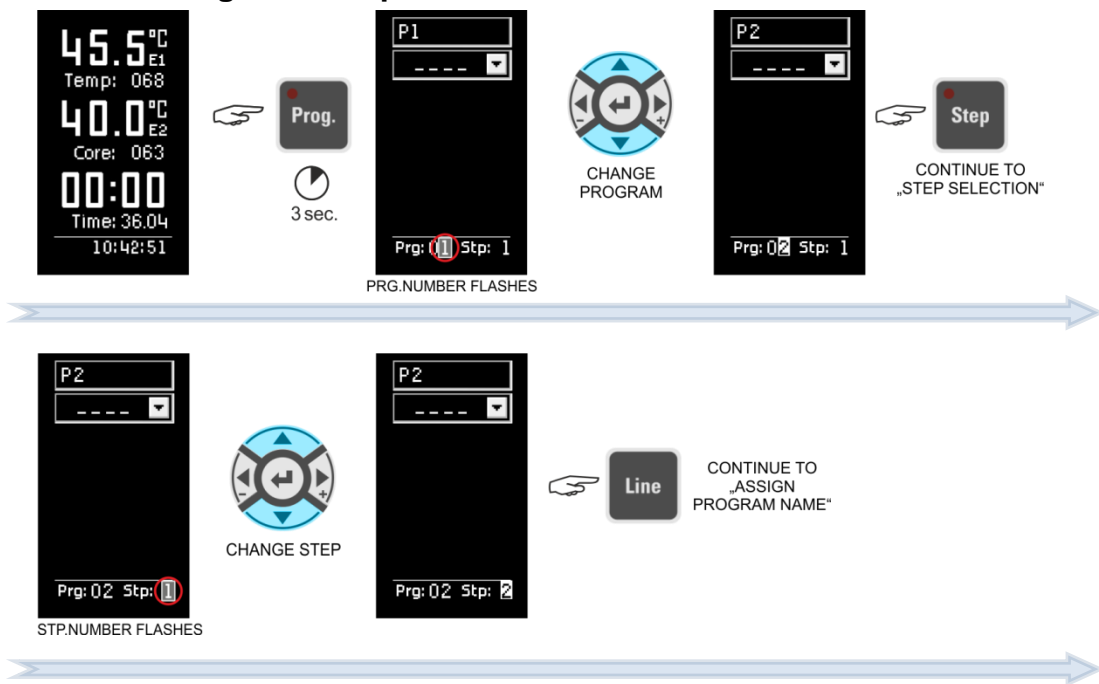

6.4.2.2 Program entry

Hit
 The program name can consist of max. 8 characters.

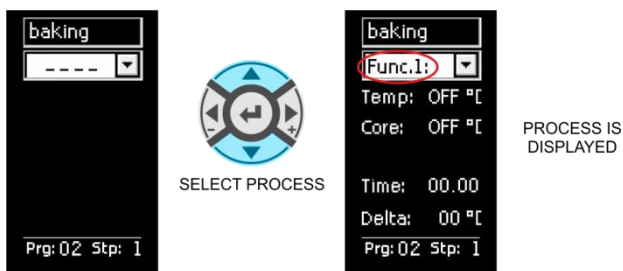
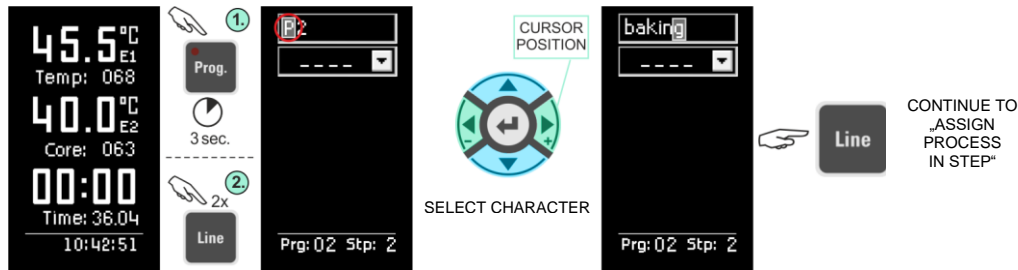

6.4.2.3 Changing nominal values within a step

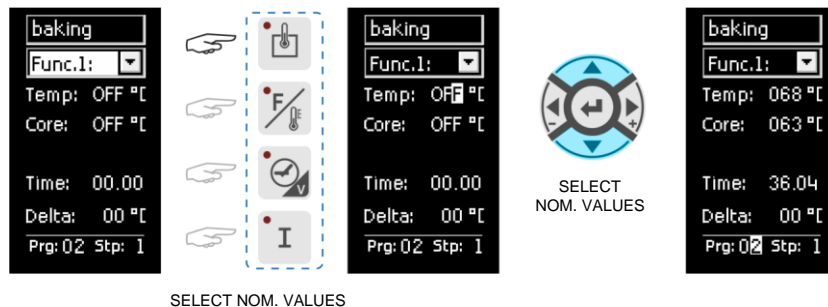

Hint
 Only nominal values that have been enabled in the configuration can be entered/ changed here.

6.4.2.4 Terminating programming mode

Press the **Prog.** button for about 3 seconds and programming mode will be terminated.

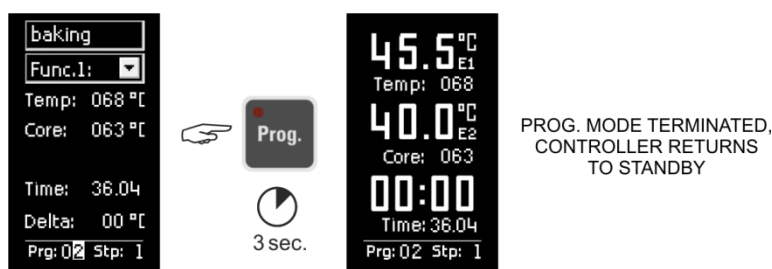

6.5 Linking programs

If the programme linking function has been programmed by the service technician, it is possible to link several programmes. If the last program step in a program has been configured and step 1 of the subsequent program has also been configured, both programs will automatically be linked. If the last step of a program is not configured, the controller will end the program after the last pre-programmed step has finished.

Hint	
	The number programs and steps can be pre-programmed by the service technician to suit your requirements. (<i>Service / program, number of steps</i>)

6.6 Copying, deleting and inserting programs/steps

Be aware	
	Access to programming mode is only possible when the pre-set number of programs is greater than 0 (<i>please ask your service technician</i>).

„Program“ box MKA 500

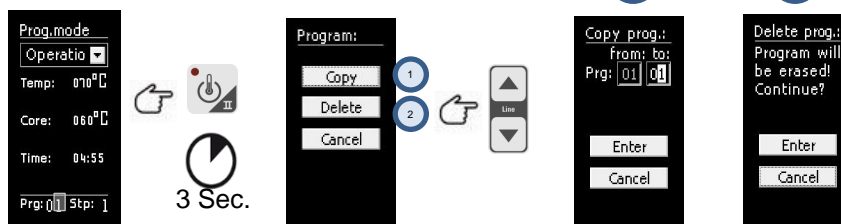

Prog.No. is flashing

„Program“ box MKA 800

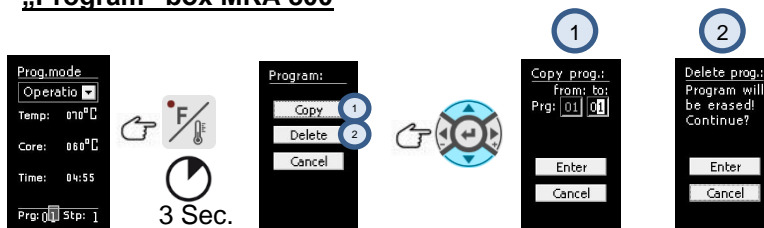

Prog.No. is flashing

1 Copying a program:

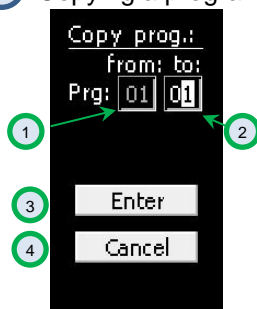

The program to be copied is shown in box 1

Select the program number you want to copy 2

Confirm your entry by pressing Enter (box 3), or cancel by pressing Cancel (box 4).

2 Deleting a program

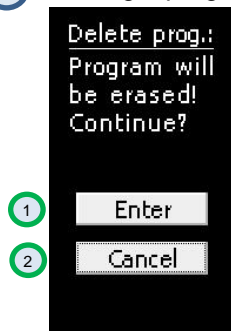

Deleting a previously selected program.

Confirm your entry by pressing Enter (box 1), or cancel by pressing Cancel (box 2).

„Step number“ box MKA 500

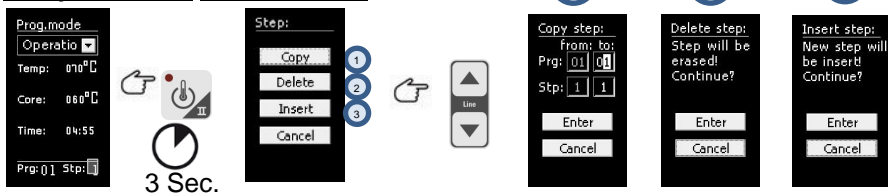

„Step number“ box MKA 800

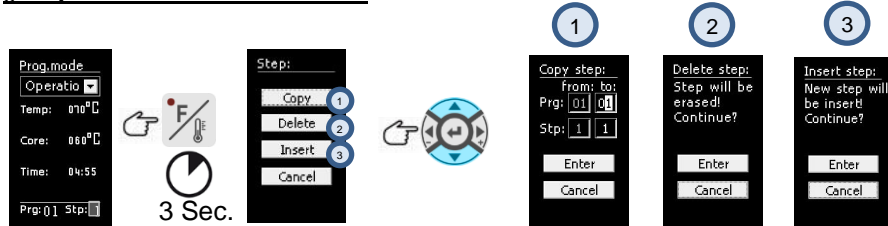

Step no. is flashing

1 Copying a step

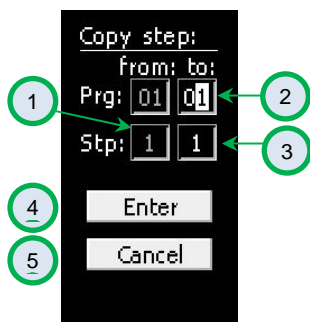

The program to be copied is shown in box 1.

Select the program number you want to copy (box 2).

Select the step number you want to copy (box 3).

Confirm your entry by pressing Enter (box 4), or cancel by pressing Cancel (box 5).

2 Deleting a step

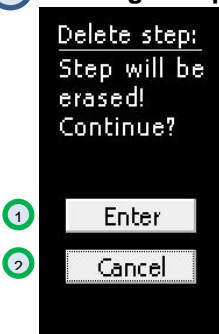

Deleting a previously selected step.

Confirm your entry by pressing Enter (box 1), or cancel by pressing Cancel (box 2).

3 Inserting a step



Inserting the previously selected step.

Confirm your entry by pressing Enter (box ①), or cancel by pressing Cancel (box ②).

Be aware	
	<p>When you press the „Enter“ button, the step will be automatically copied.</p> <p>A step which already exists in this position will be overwritten!</p> <p>Deleting or inserting steps can lead to an unintentional linking of programs or the breaking up of a previous program link!</p>

7 Operating mode - displays and settings

The controller is in operation, this means a program is running.
 The LED in the „Start/Stop“ button is lit. On the status bar the states of the relays are shown¹.

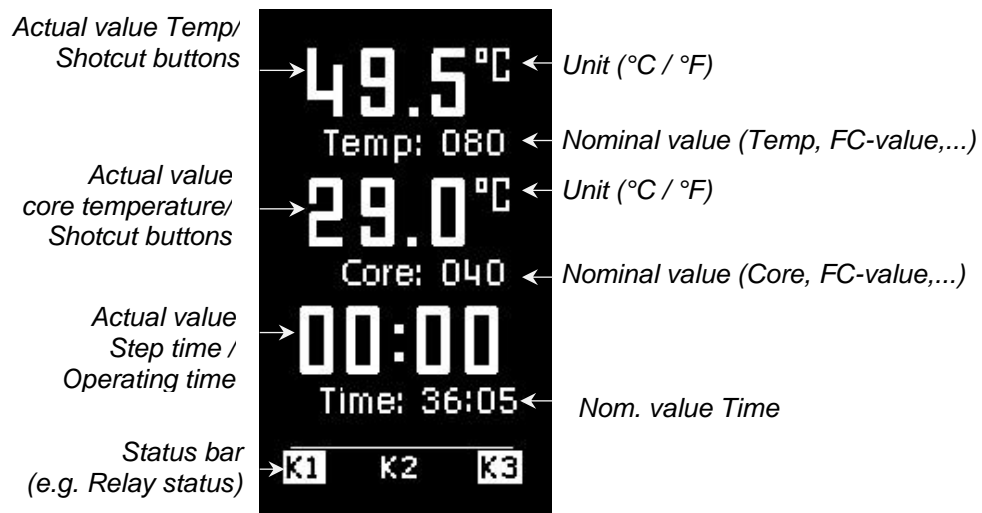

Figure 11: Operating mode

7.1 Nominal values

A service technician can make nominal values available by changing the configuration of the controller. The relevance of these nominal values can vary, this is why your service technician should explain them to you.

¹ Depends on whether the setting has been enabled under Item 8.3 Status bar display.

If additional nominal values (e.g. FC-value, Delta temperature, optional regulators) or aggregate buttons have been enabled, the relevant nominal and actual values are displayed in operating mode and can be changed transiently.

Be aware



If you change a nominal value while a step is running, then this value applies only for the duration of the current step. The value is not saved and is only valid until the step ends. If you want to save nominal values permanently, you have to change them in "Programming mode", page 24.

Be aware



In waiting mode nominal values can only be changed in the manual program (Prg:00), directly in operating mode. Changing nominal values in a standard program is only possible when you are in programming mode.

7.1.1 Aggregate/relais and digital inputs display

On the status bar all relays and their status are shown.



Relay K1 on -- Relay K2 off -- Relay K3 on - Relay K4 off -- Relay K5 off

All digital inputs (if configured) are shown on the status bar together with their respective operating status.



Digital inputs D1, D2, D3, D4 have been configured.

D1 closed - D2 open - D3 closed - D4



Digital inputs D2 and D4 have been configured.

D1 does not exist - D2 closed - D3 does not exist - D4 open

7.1.2 Aggregate modules

If aggregate modules have been enabled, you can influence them. Types of modules available, options for entering values and the unit scale in which these values are entered, all depend on the configuration and are determined by the manufacturer. Please ask your service technician for further information.

Be aware



These changes are only valid in the current step. They are not permanently saved and only apply until the end of the step!

Aggregate module (e.g. as a button for actuating relay K2)

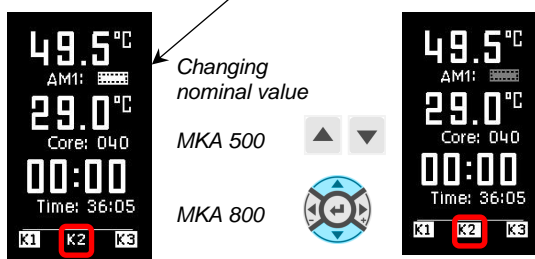

7.1.3 Optional control loops





The nominal values of the optional control loops (*if configured by a service technician*) can be pre-programmed individually in the program steps.

If additional control loops or additional sensors have been configured for the process that is currently in operation, they will be displayed together with their current temperature values (actual values).

7.2 Status bar

Different fixed messages, relay status, batch number, program/step number or the current time of day can all be shown on the status bar.

Use the arrow buttons to make changes to the status bar display

	Hint
The   buttons (MKA 500) /  (MKA 800) are used to skip between the different lines on the status bar. You can only skip between lines when nominal values are not focussed/highlighted	

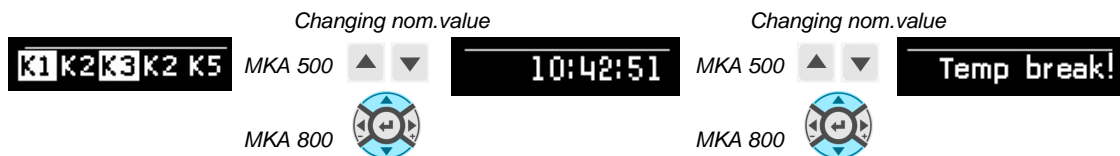

7.2.1 Program progression (from version V00.06 onwards)

On the status bar the progress of the program is shown as a progression bar. The total program runtime or remaining program runtime (total time of all program steps), respectively, is displayed graphically.

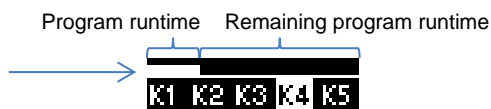

Display in percent:

Display of the remaining program runtime as a time value or as a percentage of the total program runtime.

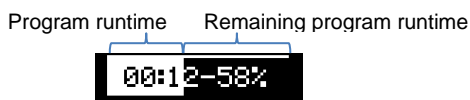

7.2.2 Remaining program runtime

The remaining program time is also calculated when steps without a step time have been pre-programmed.

If a step without a step time is in progress, the remaining program runtime can of course not be counted back. In such steps the colon in the remaining program runtime display will not be flashing.

7.2.3 Messages (system status messages)

Here all the messages that have been configured for this process or program are shown, together with their current status.

	Hint
Several messages can be shown one after the other.	

Hint
 Messages are for information only and are not sent to the „VisuNet“ recording program.

7.2.4 Alarms

Here all the alarm signals that have been configured for this process or program are shown, together with their current status.

Hint
 Alarms are critical operating status, which are sent to the „VisuNet“ recording program and logged.

7.3 Alarm signal

If an alarm has occurred, for example through a sensor break or a digital input (alarm), the „Step“ box will be flashing alternately (*light and dark*). On the status bar the alarm and its cause (e.g. *temperature sensor break*) will be shown.

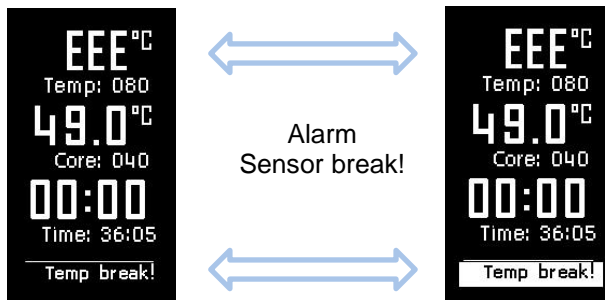

	Be aware
Temperature sensor break, program is terminated. Core sensor break, program is terminated only when nominal value is pre-programmed.	

7.4 Program runtime, operating time display in operating mode

Press the “Time” button for about 3 seconds to display the program runtime and /or the remaining program runtime while a program is in operation.

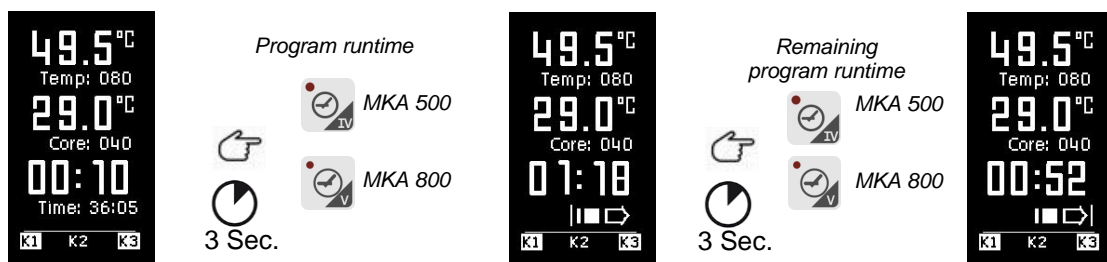

Current step time:
 Runtime of a program

With nominal step time = 00:00
 Step runtime

With a nominal step time of >00:00
 Remaining runtime of the step

Remaining program runtime:

Time interval that remains until the end of a program (goes beyond individual steps). If a step without step time limit exist in the remainder of the program sequence, the value 00:00 will be shown.



Program runtime:

Duration of the current program (goes beyond individual steps.)

8 Profile settings

All available settings are compiled for the operator under profiles.

You do not need a password to access profiles. The settings under this code do not change the controller settings.

MKA 500



or



MKA 800



or

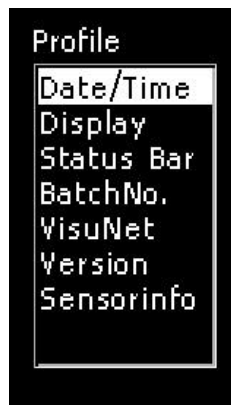

Figure 12: Profile

8.1 Setting date and time of day

Setting the current date and time.

MKA 500



MKA 800



 **Factory setting:** Central European Time.

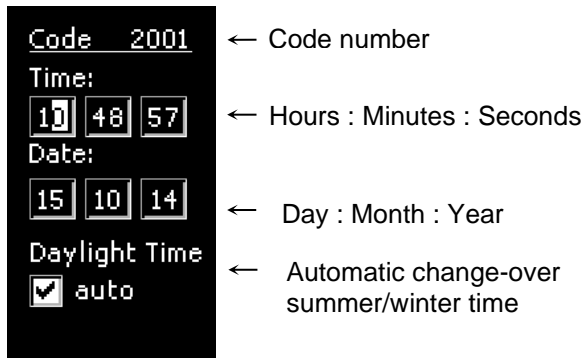

If you want to change the date and/or the time of day, select the relevant box (press 'Line' button to skip between the edit boxes) and use the 'up' or 'down' buttons to make changes to the date or time. When you leave the code (see 4.8 Leaving code setting) the entered changes will be saved.

8.1.1 Automatic change-over between summer and normal time



Die Automatic change-over from summer to normal time is active when there is a tick in the Check box „Daylight Time“.

Summer time starts on the last Sunday in March at 2.00 o'clock and ends on the last Sunday in October at 3.00 o'clock. This means that the clock moves forward by one hour at 2.00 a.m. on the last Sunday in March and moves back by one hour at 3.00 a.m. on the last Sunday in October:

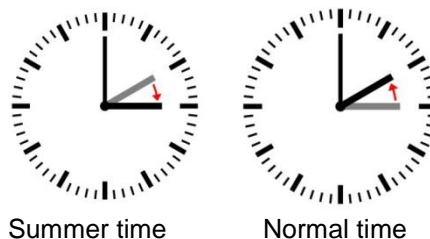

	Hint
	<ul style="list-style-type: none"> - The time change can only happen in standby mode. - The week days (<i>last Sunday</i>) are calculated automatically from the date)

8.2 Display settings

Changing display settings in standby and during operation.

MKA 500



MKA 800



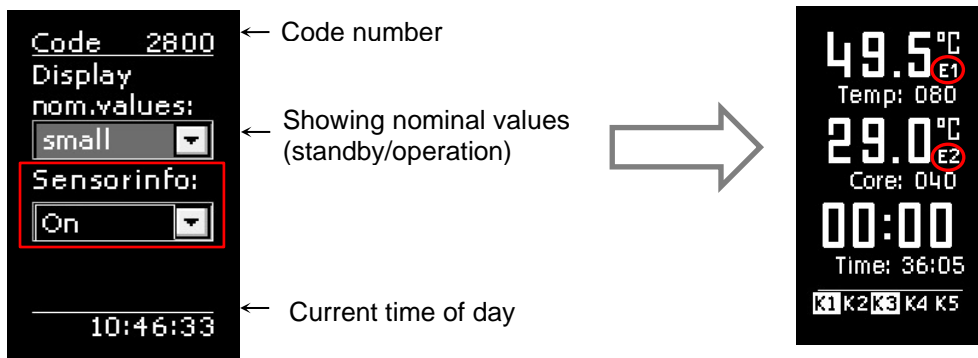

 **Factory setting:** Nominal values are shown

8.3 Status bar display

Changing the display settings of the status bar in the operations window.

MKA 500



MKA 800



When a value has been activated you can use the arrow buttons „up“ or „down“ **during operation** to skip between values on the status bar (see item 7.2 "Status bar", page 32).

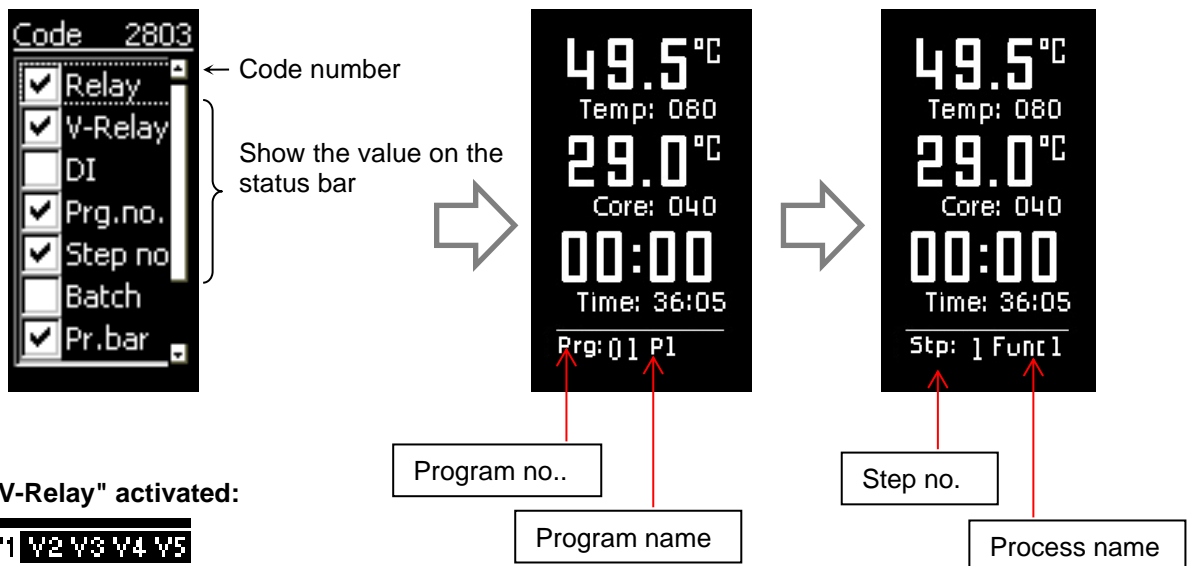



"V-Relay" activated:

V1 V2 V3 V4 V5

Current status on the status bar above
V1 = switched on/ V2 to V5 = switched off

	Hint
The virtual relays can be labelled/named and individually configured by your service technician.	

	Be aware
Skipping between values on the status bar is not possible while you are entering values.	



 **Factory setting:**
 The following values are activated:

Relay
 Clock (*current time*)



8.4 Enabling signal relay

Settings for activating the signal relay.



The time interval when you want the signal to be active can be pre-programmed under this setting. If a certain time period has been pre-set (larger than zero), the controller can only switch on the signal during this particular time period. In addition, before the start of every program, there is the option of the controller asking you, whether you want to use the signal alarm function for this program or not.

Code 5037	← Code number
Signal enable	
No 	← Activating signal
Signal time:	
from 08 10	← Signal time interval from:
until 15 10	← Signal time interval to:
Prg.sig.start:	
No 	← Signal programmable before the start of a program



 **Factory setting:** Signal enable: "Yes"
 Time from: 00:00 to 00:00 (*means: Signal can always be switched on*)
 Signal programmable before the start of a program (Prg.sig.start): "No".

	Be aware
<ul style="list-style-type: none"> ▪ If you chose "Signal enable" "No", the controller will never switch on the signal. ▪ If „Signal programmable before the start of a program“ (Prg.sig.start): is set to "Yes" , you can activate the signal before a program start (Standby mode) by pressing the button  for 3 sec. (button LED is lit), or you can de-activate it (LED is off). 	





If an alarm is triggered (signal relay is actuated), you can acknowledge it by pressing the

 button (MKA 500) /  (MKA 800) for  3 sec.

If there no is current alarm event, you can activate or de-activate the alarm during operation by

pressing the button  (MKA 500) /  (MKA 800) for  3 sec.



Leave this setting by pressing buttons  or  (MKA 500) /  or  (MKA 800) for 3 sec. 

8.5 Enabling a batch number

Enabling batch number entry before every program start.

MKA 500



MKA 800

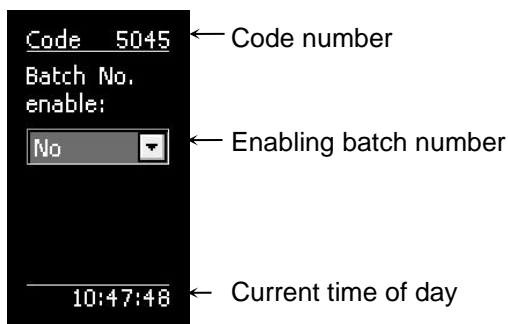

 **Factory setting:** Batch number entry is disabled.

Hint
 A batch number can have a maximum of 10 characters. You can enter a mixture of letters and numbers.

8.6 Data logger

MKA 500



MKA 800

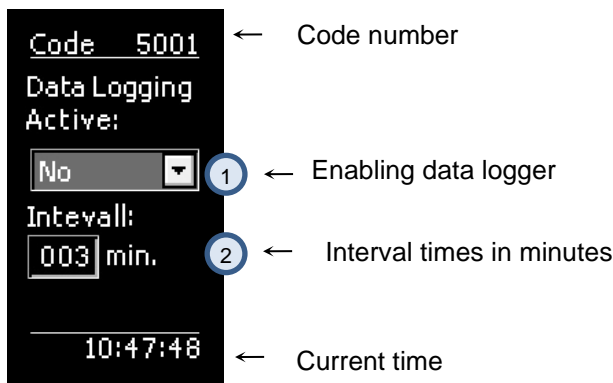

During operation the controller can send the current program data to a data logger (*separate hardware is needed DLK-1-Kit*).

DLK-1-Kit consists of: Additional board ZSU, µSD card, 3-part USB socket port.

① Data Logging Active: Display of the currently pre-programmed status

„No“ = Data logger is inactive

„Yes“ = Data logger is active

„Auto“ =Automatic logging of data: Processes are automatically logged onto a µSD card, when VisuNet is not active

② Interval: display the time intervals at which you want the data to be logged.



Factory setting: "Auto"= automatic logging of data
 Interval = 000 min.

Hint	
	At a pre-set interval time of 0 min, the data is logged at 30-second intervals. If the data logger is activated (Active = Yes), there may be a slight delay of up to 3 seconds at the start of a program.

Hint	
	The data logger can only be used when VisuNet has been enabled and a µSD card with sufficient memory has been inserted in the relevant recess.

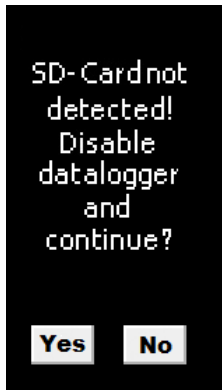

If the „Data logger“ option is enabled, but the required hardware (SD card) has not been inserted or if there is not enough disk space on the hardware, the controller will recognise this and display a message before the program start. If the message is confirmed with „No“, the program start will be aborted. If the message is confirmed with „Yes“, the data logger will be disabled on a temporary basis and the program will be started.

Be aware

 **Temporarily switched off means until the next reboot of the controller.**

Be aware

 While data is being logged (Controller is in operation, program is running) there should not be a USB stick inserted in the controller. Data received from the controller is internally saved onto the µSD card. This data can then be transferred onto a USB stick (the controller must be in standby mode when you transfer the data).

Hint

 If there is not enough memory on the SD card, you can save the data from the SD card onto a USB mass storage device and free some memory.

8.6.1 Copying data onto a USB stick

Be aware

 The USB interface of additional board ZSU is only meant to be used to read out/retrieve data logger files. **Please DO NOT connect any USB periphery devices** (key board, mouse, printer) **at this interface.**
All common USB mass storage devices in FAT16 and FAT32 format are supported
NTFS formatted USB mass storage devices and external hard disks are not supported!



If a USB Error while copying is connected to additional board ZSU, the following message will be shown:

"Move all data to USB! Continue?"



Select „OK“ or „Cancel“ with the buttons



Confirm selection with

If you confirm this message with „OK“, all data will be copied from the SD card onto a USB mass storage device.

After the data has been **successfully** copied onto the USB device, the data is deleted from the µSD card. The copied data can now be imported into VisuNet (see manual VisuNet, Wirelsss data transfer).

Possible messages and what they mean:

- Process is terminated with „Cancel“: *"Please remove the USB flash drive!"*
- Starting the process of copying the data: *"Move all data to USB! Continue?"*
- Copy process is running: *"Please wait while files are being copied!"*
- Copy process is finished: *"All files have been copied. Please remove the USB flash drive!"*
- No data on the SD card: *"FILE NOT FOUND! Please remove the USB flash drive!"*

- Error while copying: "FILE COPY ERROR! Please remove the USB flash drive!"
- Error while copying because USB was removed: "FILE COPY ERROR! USB mass storage not detected!"
- Error while copying because SD card was removed: "FILE COPY ERROR! SD-Card not detected!"
- Error message because there is not enough memory space on USB mass storage device: "Not enough memory on device! Please remove the USB flash drive!"
- Error because the SD card cannot be found: "SD-Card not Found! Please remove the USB flash drive!"

8.7 Enabling VisuNet program

i Hint
This function will be configured by your service technician!

8.8 Version number display

MKA 500



MKA 800



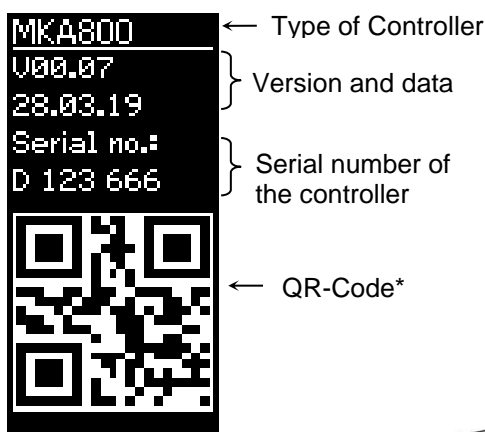

This code setting allows you to see the software version of the controller. You need the version number in case you have to contact the manufacturer.



i Hint
<p>*QR-Code: Many mobile phones and PDAs have an integrated camera and Software that can recognise QR-codes. If you scan the code, the aditec homepage can be opened. Here you will find the current user manual for „MKA500/MKA 800“.</p>



Button  (MKA500) /  (MKA800) will be flashing. Press the button and further functions will be shown:



1. Hardware version: 04/15, 09/21
2. Display typ: SSD1325, SSD1357
3. Uptime: Time since the controller was last switched on
4. Information on the last loaded configuration
- 4.1 Date and time of last saved configuration

[zu 4]

MA (Manuel)	Manuel loaded configuration, e.g. service programme or by changing a code setting.
UP (Update)	Configuration was saved during the update of the controller
CO (Code)	Code 9993 was executed - basic configuration loaded
BS (Basic Settings)	Basic configuration - loaded during the boot process
FS (Factory Settings)	Total deletion - carried out in the boot process

8.9 Sensor information

MKA 500



MKA 800



Information concerning sensor configuration is shown under code setting „ Sensor info“. This page is for information only and changes to the settings cannot be made on this page.

If several sensors are allocated to one measured variable, the lowest, highest and average values are used for the control process and are displayed. (*it depends on the configuration*) This means it is not always immediately obvious which measured value is used for the control process. You can look at the actual values of the sensors (*separately*) under code setting „Sensor info“.

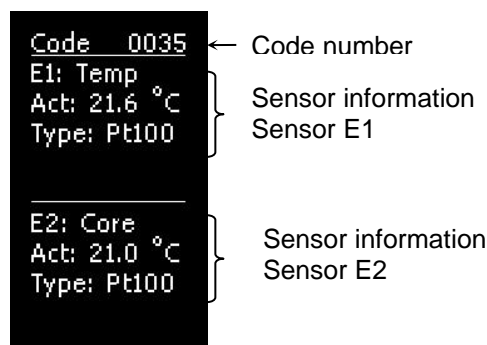

8.10 Screen saver

Settings for the screen saver

MKA 500



MKA 800



 **Factory setting:** screen saver inactive

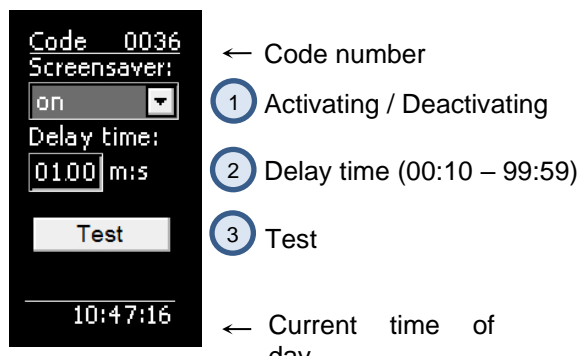

Figure 13: Screen saver

The screen saver prolongs the life of your monitor:

- The brightness of the LEDs will fade with time.
- Power consumption is reduced because only some pixels are active.

The **screen saver** comes on after a pre-set time interval, when none of the key board buttons have been pressed. It stops as soon as an entry is made (the key board is used again).

- 1 Activating/ deactivating the screen saver
- 2 Delay time interval, before the screen saver comes on , can be pre-set. Entry range from 00:10 to 99:59 (*minutes : seconds*).
- 3 Checking on the screen saver

9 Power failure

If a running program was interrupted by a power failure or because the appliance was switched off, the controller will automatically resume the interrupted program as soon as power is restored.

	Be aware
	<p>Your service technician can pre-program how the controller should react in case of a power failure, by making the relevant changes in the configuration.</p> <p><i>Resuming a program after a pre-programmed „Temperature difference“</i></p> <ul style="list-style-type: none"> • „always“ resume after a power failure • „never“ resume after a power failure

10 List of errors (possible problems)



Occurring problem	Possible cause	Possible action
Program does not start	Program is empty	Pre-program a process
	Pre-set start time has been entered („Start“ button is flashing)	Press the „Start/Stop“ button.
Program is terminated right after the start	Possible break in a temp., core or humidity sensor , display will show „EEE“ for sensor break or „--“ for sensor short circuit	Replace the faulty sensor or call your service technician. Afterwards the temperature has to be checked. The service technician might have to adjust the controller.
Program is running fast through all the steps and ends	- the pre-set core temperature value is not reached - FC-value is not reached	Check the pre-programmed values of the program.
	Nominal core value is higher than the pre-programmed nominal temperature value (negative core shut-down, core temperature is below the nominal temperature value)	 Page 20 „Nominal core temperature“
Running program switches automatically into the subsequent program	Program link is activated	Press the „Stop“ button  Page 23 „Linking programs“
Controller cannot be started	Disruption of the power supply	Take the controller off the power supply for at least a minute. Now switch the controller on again and try to operate it.
"Short circuit temp.sensor"	Temperature sensor defect Running program is terminated	Replace the sensor or assign a different sensor to the measured variable under Code 4400.
"Break temp. sensor"		
"Short circuit core sensor"	Core temperature sensor defect Running program is terminated	Replace sensor. If you want to continue using the appliance even without a core sensor, enter „00“ for the core and FC-value Replace the sensor or assign a different sensor to the measured variable under Code 4400.
"Break core sensor"		
"Sensor fault: opt. regulator x Short circuit/break"	Temperatur sensor of an optional regulator (1 to 6) defect. Additional regualtion is disabled.	Replace sensor. In order to get rid of the error message, disable the sensor under Code 4400.
"Sensor fault: opt. regulator x Overheating!"	Temperature at the sensor of an optional regulator (1 to 6) is higher than the maximum permissable temperature Additional regualtion is disabled.	If option "Enable = manually" is pre-programmed under Code 1024, you have to re-enable the regulator under Code 5678.

Table 6: List of errors

11 Connecting the controller to a PC

The controller comes with a USB-interface as standard, which allows you to connect it to your PC, however programming and configuring the controller via this interface is not yet possible.

This is why you need an additional board in order to program and configure the controller (see item 11.1.1 / 11.1.2).

A connection to the PC has the following advantages:

- The controller can be comfortably **programmed and configured** via a PC.

Hint	
	The required software will be supplied free of charge by aditec. Please ask for the aditec service program!

- Remote maintenance with the aditec service program
- Recording, documenting and archiving in compliance with HACCP with the aditec visualisation system **VisuNet**.
- The visualisation program **aditec VisuNet allows you to connect** the controllers to a superordinate surveillance system. This enables you to monitor and log temperature and humidity profiles of processes ensuring comprehensive quality control of the treated products in your plant (in compliance with ISO 9000).

Hint	
	Please ask aditec for the information on the VisuNet program!

11.1 Connection cables, different types of connection

11.1.1 Connection via an Ethernet interface:



	In order to connect the controller to a PC via an Ethernet interface you will need: <ul style="list-style-type: none">• an Ethernet cable (RJ45)• a ZSL board (<i>additional board Ethernet, see Figure 14</i>)
---	--

Figure 14: ZSL-board

Hint	
	If you want to use this option, please approach your service technician.

11.1.2 Connection via a RS485 interface:

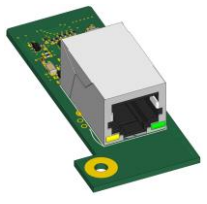
	In order to connect the controller to a PC via a RS485 interface you will need: <ul style="list-style-type: none">• a 3--core shielded cable• a USB to RS485 converter (<i>e.g. US-4561</i>)• a ZS4 board (<i>additional board RS485, see Figure 15: ZS4-</i>)
---	--

Figure 15: ZS4-board

11.2 Enable VisuNet

In order to work with the visualisation program it has to be enabled. Further information is available from your service technician or from the company aditec

12 Technical data

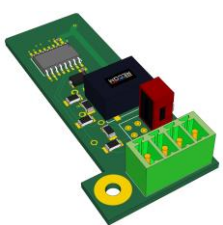
12.1 MKA 500

See data sheet: Programmable controller MKA 500 »for cooking, universal, baking, boiler systems and autoclaves

http://www.aditec.net/MKA500_data-sheet_en.pdf

12.2 MKA 800

See data sheet: Programmable controller MKA 800 »for cooking, universal, baking, boiler systems and autoclaves

http://www.aditec.net/MKA800_data-sheet_en.pdf

13 Dimensions / connection diagrams

13.1 Dimensions / connection diagrams MKA 500

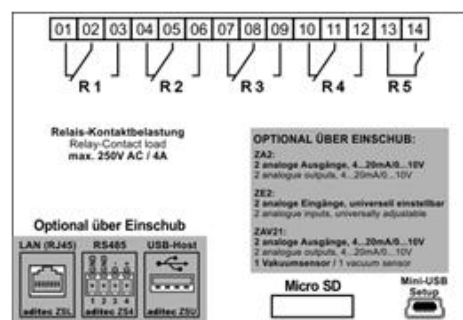
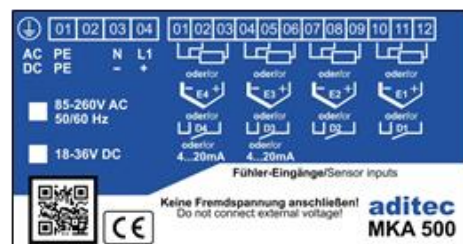
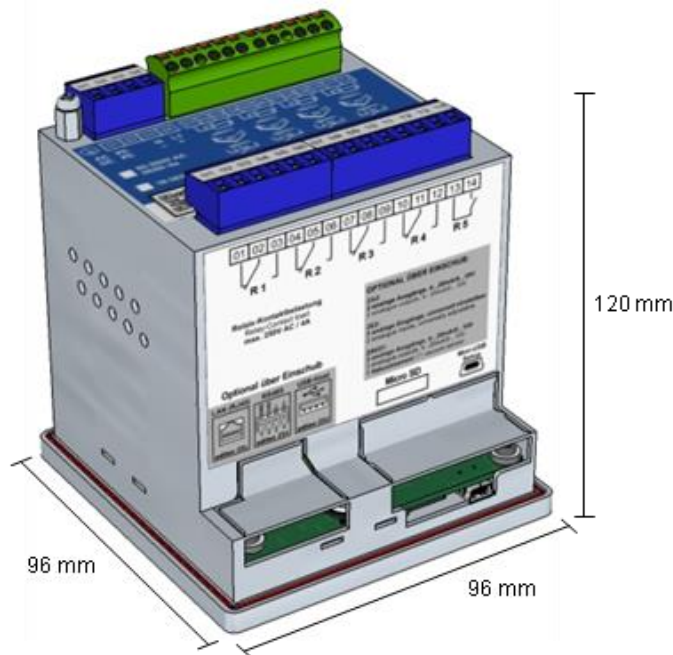

13.2 Dimensions / connection diagrams MKA 800

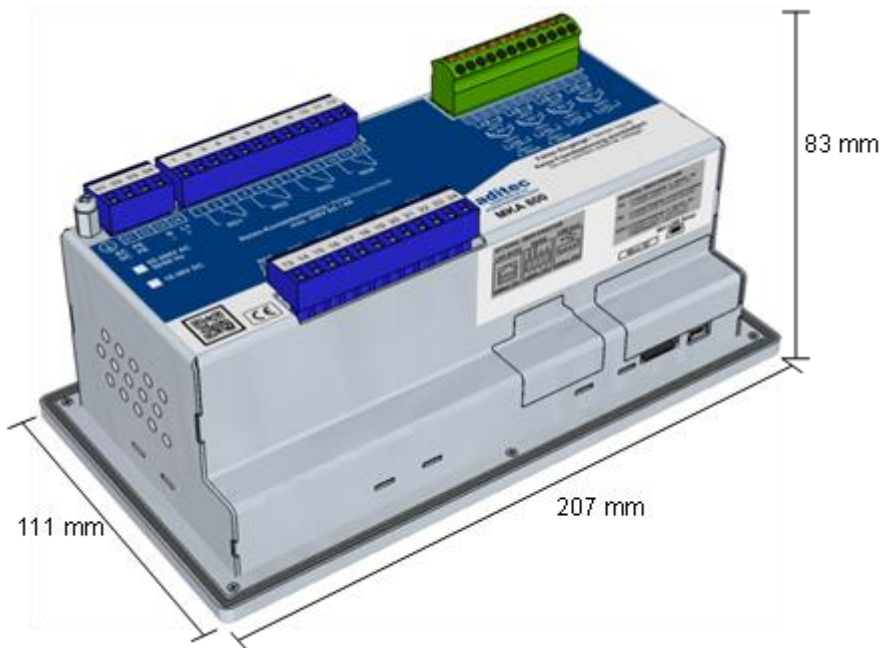
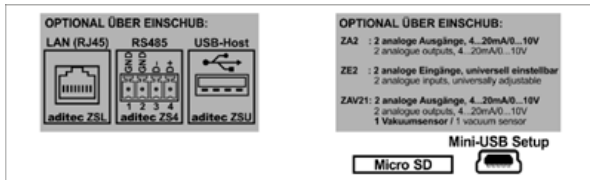
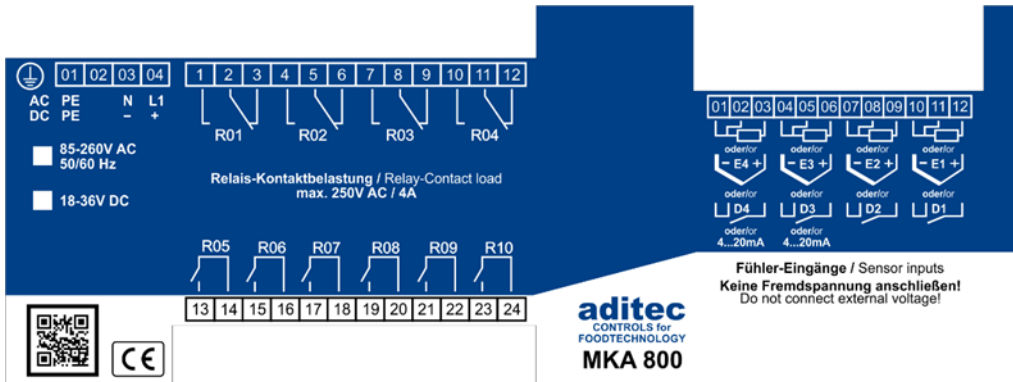

14 Additional boards / Interface options

Recess left:

► **ZSL**
 Additional board
 Ethernet

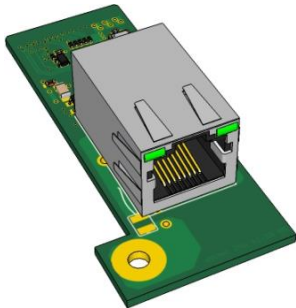

► **ZS4**
 Additional board
 RS485

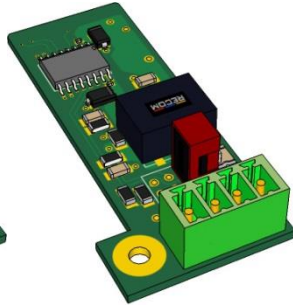

► **ZSU**
 Additional board
 USB host

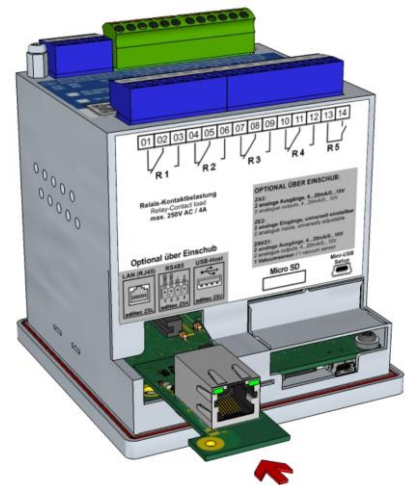
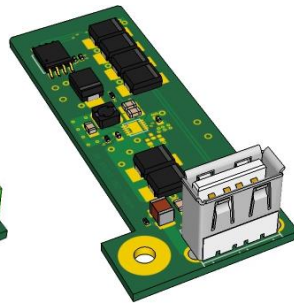

Figure 16: MKA500
 Recess left

Recess right:

► **ZA2**
 Additional board
 2 analogue outputs
 4...20mA/0...10V



► **ZAV21**
 Additional board
 2 analogue output +
 1 vacuum sensor
 universally programmable

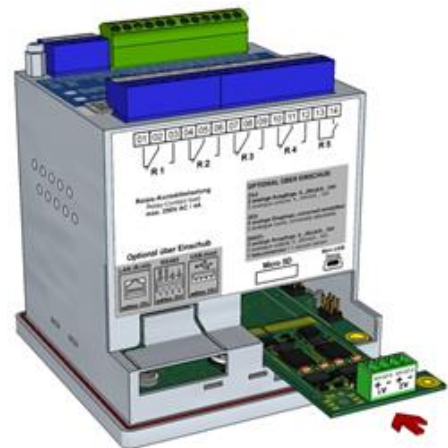
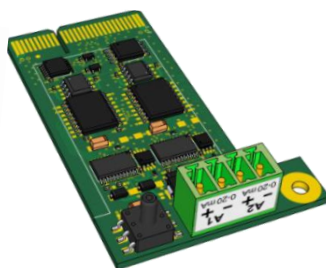
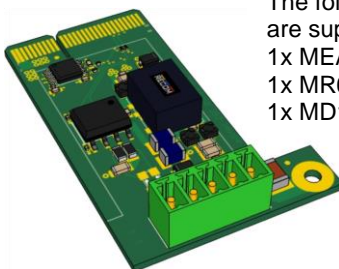

Figure 17: MKA500
 Recess right

► **ZSC**
 Additional board
 (MKA 500/800 from SW V00.11 and from HW 09/21)



The following CAN modules
 are supported
 1x MEA24
 1x MR6
 1x MD12

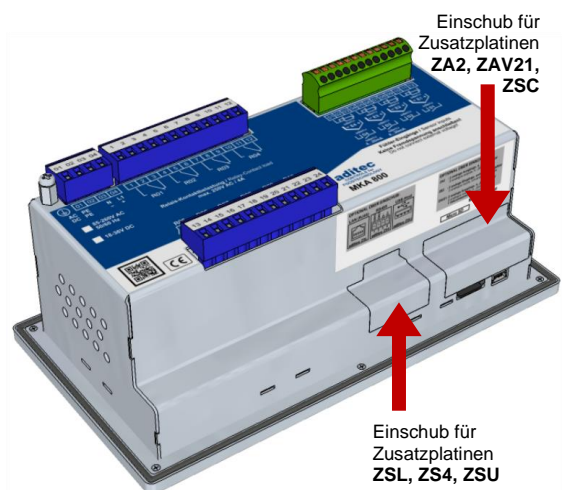

Figure 18: Recess for additional boards MKA 800

15 Index

A		N	
<i>Aggregate modules</i>	31	<i>negative values</i>	12
<i>Aggregate/relais display</i>	31	<i>Nominal core temperature</i>	15, 45
<i>Alarm signal</i>	33	<i>nominal temperature</i>	15, 16, 18, 45
<i>Alarms</i>	33	<i>Numbers</i>	13
B		O	
<i>Batch number</i>	22	<i>Operating mode</i>	30
<i>Button functions</i>	8	<i>Operating time display</i>	33
C		<i>Optional control loops</i>	31
<i>Check boxes</i>	13	P	
<i>Connection cables</i>	46	<i>Power failur</i>	44
D		<i>Profile settings</i>	34
<i>Date</i>	34	<i>Program runtime</i>	33
<i>Delta temperature</i>	16	<i>Program start</i>	22
<i>Display settings</i>	35	Q	
<i>Drop boxes</i>	14	<i>QR-Code</i>	41
E		R	
<i>Edit box</i>	12	<i>RS485</i>	46
<i>Ethernet</i>	46	S	
F		<i>Safety instructions</i>	51
<i>FC value</i>	16	<i>Scrolling characters</i>	12
H		<i>Short circuit</i>	45
<i>Housing</i>	51	<i>Shut-down condition</i>	18
I		<i>Software</i>	41
<i>Interface</i>	46	<i>Special characters</i>	13
<i>Intrface</i>	46	<i>Starting time</i>	23
L		<i>Status bar display</i>	36
<i>LED</i>	5, 10, 23, 30, 37	<i>step time</i>	6, 8, 15, 18
<i>Letters</i>	13	<i>Step time</i>	6, 7
<i>List boxes</i>	14	<i>switch-off condition</i>	18
<i>List of errors</i>	45	<i>Symbols</i>	4
M		T	
<i>Messages</i>	32	<i>Time</i>	34
M		V	
Messages		<i>Version number</i>	41
32		<i>VisuNet</i>	41, 46



Hint

If you want to look for further terms that do not appear in this index, please use the search function in Adobe Acrobat Reader.

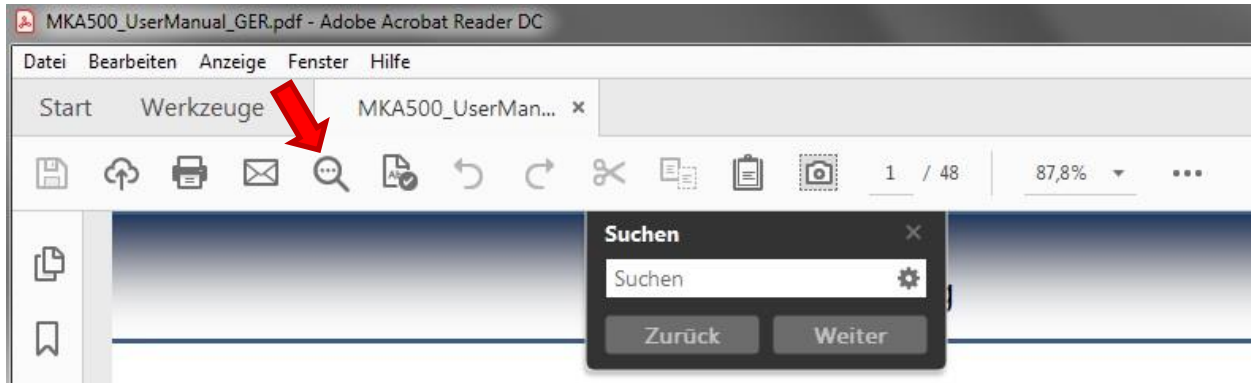

16 Safety instructions

To avoid any danger of electrocution, the housing must never be removed nor opened at the back. None of the parts inside can be serviced by the user himself. Leave the servicing to the experts! To avoid fire or electrocution this appliance must not be exposed to humidity or rain.

1. Manual: Read all safety instructions and all items in the user manual, before using the controller for the first time! Keep the safety instructions and the user manual in a safe place in case you need to refer back to them at a later date!

2. Installation instructions: The appliance should always be installed by an authorized and experienced specialist. Please follow the specific safety instructions as well as the VDE guidelines during installation. The appliance should only be fitted in an approved and specifically designed waterproof switching cabinet (metal housing) and should only be used for the purpose it was designed for and within the limits of its technical data.

We recommend that any down-streamed inductors (relays, contactors, signal transmitters, valves etc.) with RC elements should be checked for interference. These are available on the retail market (e.g. Siemens 3 RT1916, Klöckner-Moeller, etc.).

3. Analogue in- and outputs: Do not apply separate source voltage to the in- and outputs (4-20mA / 0-10V and Pt100)

4. Sensor leads as well as analogue in and outputs should be run separately from any voltage carrying leads, this also includes control wires carrying separate source voltage. It is vitally important that the sensor leads have a metal shielding and that this shielding is connected to the sensor housing itself.

5. Relay outputs: The relay outputs are potential free and the maximum load of 250V AC and 4A must not be overshoot.

6. Water and humidity: Never use the unprotected appliance near water, e.g. near a bath tub, water basin, sink, washing machine, a damp cellar or near a swimming pool. The appliance is only waterproof on the front (in compliance with IP65 or IP67). The back and side panels must not come into contact with water.

7. Ventilation: The appliance must have sufficient ventilation, the ventilation slits in the housing must never be covered up, or blocked by objects inserted into the slits.

8. The effects of heat: Keep the appliance away from heat sources, like radiators, heating conduits, ovens, and other elements that may radiate heat.

9. Energy sources: The appliance should only be connected to the power sources that are specified in the user manual or on the appliance housing itself.

10. Cleaning: Clean the display and the operator interface only with a damp, soft and clean cloth without any chemical and mechanical substances. Do not use sharp-edged tools or pointed objects or other mechanical aids.

11. Appliance not in use: When you know the appliance is not going to be used for a longer period of time, it should be disconnected from the mains.

12. Contaminants: You have to be extremely careful that neither liquids nor foreign objects can get into the appliance through the openings in the housing. If objects or liquids have contaminated the inside of the appliance, it has to be disconnected immediately and sent in to the manufacturer.

13. Servicing after damage: The appliance may only be serviced by a qualified specialist. The user should only do the servicing tasks he is meant to do according to the user manual. For servicing that exceeds his authority, a specialist should always be contacted.

Hint	
	Never make any technical alterations to the appliances, unless they were specifically approved by aditec gmbh. Unauthorized alterations will invalidate your warranty.

For enquiries, orders and repair enquiries, please contact us at the following address:

Measurement and Control technology Hardware development Software development Specialised electronics Food technology Process visualisation	 <p>aditec CONTROLS for FOODTECHNOLOGY</p>	aditec gmbh Talweg 17 D-74254 Offenau Tel.:+49(0)7136 96122-0 Fax:+49(0)7136 96122-20 www.aditec.net eMail: info@aditec.net
--	--	---